

C-PHB-B-L2F-15L/22L/30L Series

Premium LED Linear High Bay

Replaces 250W to 400W HID or 4-6 Lamp, 54W T5HO



DEMAND MORE WITH PREMIUM LED LINEAR HIGH BAYS-

- 135 lumens per watt - plus, dimming and surge protection come standard



PRODUCT SPECIFICATIONS

OVERVIEW

- Delivered Lumens: 14,400, 21,300, 29,200
- CRI: >80
- CCT: Neutral White (4000K), Cool White (5000K)
- Input Power: 107W, 159W, 217W
- Dimmable: 0-10V dimming to 10%
- 10kV/5kA surge protection
- Mounting: Includes v-hook, 36' chain; Optional pendant mount kit (sold separately)
- Operating Range: -40°F to 104°F (-40°C to 40°C)
- Estimated L70 Lifetime @ 25°C: > 100,000 hours
- Power Factor: > 0.90
- Total Harmonic Distortion: < 20%
- Limited Warranty: 5 Year*
- Replaces up to 6 Lamps, 54T5HO, 400W PSMH
- Damp location rated

HIGH PERFORMANCE	PREMIUM DESIGN	RECOMMENDED USE	INPUT VOLTAGE
<ul style="list-style-type: none"> • Up to 57% energy savings compared to linear fluorescent fixtures 	<ul style="list-style-type: none"> • Vented steel design for optimal thermal management • 10kV/5kA surge protection included 	<ul style="list-style-type: none"> • Warehouses • Industrial • Retail • Manufacturing 	<ul style="list-style-type: none"> • Universal (120V through 277V Operation)

ORDERING INFORMATION

Example: C-PHB-B-L2F-15L-40K-UL-WH

C-PHB	B	L2F			UL	WH
PRODUCT	SERIES	STYLE	LUMEN PACKAGE*	CCT	VOLTAGE	COLOR
C-PHB High Bay	B	L2F Premium LED Linear High Bay	15L 15,000 Lumens, 110W 22L 22,000 Lumens, 162W 30L 30,000 Lumens, 223W	40K Neutral White (4000K) 50K Cool White (5000K)	UL Universal 120V-277V	WH White

* Lumen values apply to luminaires with standard acrylic lens. Lumen multiplier for frosted lens accessory is 0.96.

© 2020 Cree Lighting, A company of IDEAL INDUSTRIES. All rights reserved. For informational purposes only. Content is subject to change. Patent www.creelighting.com/patents. C-LITE® and the C-LITE logo are registered trademarks of Cree Lighting. The UL logo is a registered trademark of UL LLC. The DLC Premium QPL logo is a registered trademark of Efficiency Forward, Inc.

US: creelighting.com, e-conolight.com Distribution/Sales: 855-617-2733 Customer Services: 888-243-9445

Rev. Date: V2 03/17/2020

For informational purposes only. Content is subject to change. *See lighting.cree.com/warranty for details

CERTIFICATIONS-



C-PHB-B-L2F-15L/22L/30L Series

Shown with Pendant Mount Kit Accessory
(sold separately)

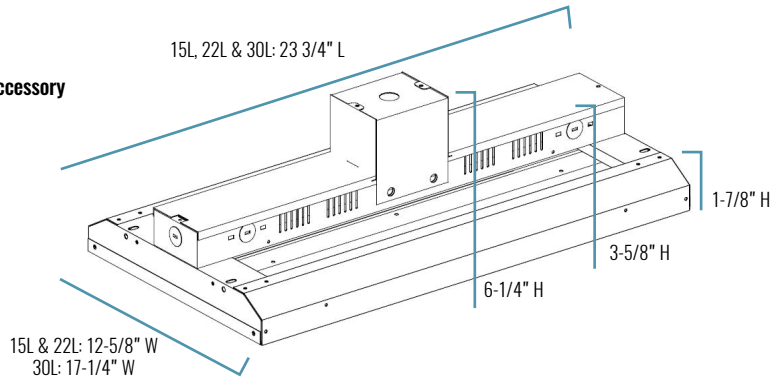

SERIES OVERVIEW

DIMENSIONS	PRODUCT WEIGHT	MOUNTING HEIGHT	SPACING
15L & 22L: 23 3/4" L x 12 5/8" W x 3 5/8" H 30L: 23 3/4" L x 17 1/4" W x 3 5/8" H	15.0 lbs.	15 to 35 feet	1 to 1-1/2 times the mounting height

FIXTURE SPECIFICATIONS

HOUSING	Vented steel housing provides thermal management through natural convection
LENS ASSEMBLY	Clear high transmission acrylic lens standard Optional: field installed frosted lens available Note: Acrylic and polycarbonate lenses not intended for use in environments where any concentrations of industrial cutting fluids are used.
MOUNTING	Includes v-hook and 36" chain; Optional pendant mount kit (sold separately); Fixture must be a minimum of 7" below ceiling Requires minimum 90°C supply conductors

ELECTRICAL PERFORMANCE

OPERATING RANGE	ESTIMATED LIFESPAN L ₇₀ AT 25°C (77°F)	POWER FACTOR	TOTAL HARMONIC DISTORTION	DIMMABLE
-40°F to 104°F (-40°C to 40°C)	>100,000 Hours	> 0.9	< 20%	Yes, to 10%

LUMEN PACKAGE	SYSTEM WATTS (120-277V)	CURRENT DRAW (AMPS)			
		120V	208V	240V	277V
15L	110W	0.91	0.52	0.45	0.39
22L	162W	1.33	0.76	0.66	0.57
30L	223W	1.82	1.05	0.91	0.79

CA RESIDENTS WARNING: Cancer and Reproductive Harm –
www.p65warnings.ca.gov

© 2020 Cree Lighting, A company of IDEAL INDUSTRIES. All rights reserved. For informational purposes only. Content is subject to change. Patent www.creelighting.com/patents. C-LITE® and the C-LITE logo are registered trademarks of Cree Lighting. The UL logo is a registered trademark of UL LLC. The DLC Premium QPL logo is a registered trademark of Efficiency Forward, Inc.

US: creelighting.com, e-conolight.com Distribution/Sales: 855-617-2733 Customer Services: 888-243-9445

Rev. Date: V2 03/17/2020

For informational purposes only. Content is subject to change. *See lighting.cree.com/warranty for details







C-LITE
LED LIGHTING

C-PHB-B-L2F-15L/22L/30L Series

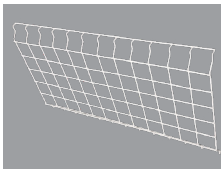
WARRANTY AND CERTIFICATIONS

WARRANTY	cULus LISTED	SURGE PROTECTION	DLC
5-Year Limited*	Damp Locations. Designed for indoor use only.	10kV/5kA	DLC Premium Qualified. Please refer to www.designlights.org/QPL for most current information.

ACCESSORIES (available with fixture purchase only)

	WIRE GUARD SKU: C-PHB-A-LHBWG-12X24 (15L/22L) C-PHB-A-LHBWG-18X24 (30L)		6' CORD WITH TWIST-LOCK PLUG SKU: C-ACC-A-CRDS-6FT-LV-TL (120V) C-ACC-A-CRDS-6FT-HV-TL (277V) C-ACC-A-CRDS-6FT-MV-TL (208V or 240V)
	PENDANT MOUNT KIT SKU: C-PHB-A-HBPM (15L/22L) C-PHB-A-223-HBPM (30L)		6' CORD WITH STRAIGHT BLADE PLUG SKU: C-ACC-A-CRDS-6FT-LV-SB (120V)
	PIR MOTION SENSOR On/Off functionality (no dim setting) SKU: C-PHB-A-HBPIR		FROSTED LENS - MADE FROM POLYCARBONATE MATERIAL SKU: C-PHB-B-L2F-1062-FST-5PK (15L/22L) C-PHB-B-L2F-223-FST-5PK (30L) Note: Polycarbonate lenses not intended for use in environments where any concentrations of industrial cutting fluids are used. 4% decrease in lumen output when using frosted lens.

PRODUCT INFORMATION

ORDERING NUMBER	DESCRIPTION	UPC	QPL REFERENCE I.D.
C-PHB-B-L2F-15L-40K-UL-WH	2' Linear High Bay, 15,000 Lumens, Chain/Hook, 40K, Clear Lens, UL, White	849665033660	PL69EAQDODSU
C-PHB-B-L2F-15L-50K-UL-WH	2' Linear High Bay, 15,000 Lumens, Chain/Hook, 50K, Clear Lens, UL, White	849665033677	PL7SHW2VCO98
C-PHB-B-L2F-22L-40K-UL-WH	2' Linear High Bay, 22,000 Lumens, Chain/Hook, 40K, Clear Lens, UL, White	849665033684	PL603JB6WM2F
C-PHB-B-L2F-22L-50K-UL-WH	2' Linear High Bay, 22,000 Lumens, Chain/Hook, 50K, Clear Lens, UL, White	849665033691	PL4JDBISQJXV
C-PHB-B-L2F-30L-40K-UL-WH	2' Linear High Bay, 30,000 Lumens, Chain/Hook, 40K, Clear Lens, UL, White	849665005988	PLSTRY5JA9CM
C-PHB-B-L2F-30L-50K-UL-WH	2' Linear High Bay, 30,000 Lumens, Chain/Hook, 50K, Clear Lens, UL, White	849665006008	PL033MOI20GG

ACCESSORY	DESCRIPTION	UPC	QPL REFERENCE I.D.
C-PHB-B-L2F-1062-FST-5PK	Frost Lens, 5 Pack for C-PHB-B 110W (15L) / 162W (22L)	849665006039	N/A
C-PHB-B-L2F-223-FST-5PK	Frost Lens, 5 Pack for C-PHB-B 223W (30L)	849665033721	N/A

© 2020 Cree Lighting, A company of IDEAL INDUSTRIES. All rights reserved. For informational purposes only. Content is subject to change. Patent www.creelighting.com/patents. C-LITE® and the C-LITE logo are registered trademarks of Cree Lighting, A company of IDEAL INDUSTRIES. The UL logo is a registered trademark of UL LLC.

US: creelighting.com, e-conolight.com

Distribution/Sales: 855-617-2733 Customer Services: 888-243-9445

Rev. Date: V2 03/17/2020

For informational purposes only. Content is subject to change. *See lighting.cree.com/warranty for details

C-LITE
LED LIGHTING