

### IMPORTANT SAFEGUARDS

When using electrical equipment, basic safety precautions should always be followed including the following:

### READ AND FOLLOW ALL SAFETY INSTRUCTIONS

1. **DANGER-** Risk of shock- Disconnect power before installation.  
***DANGER – Risque de choc – Couper l'alimentation avant l'installation.***
2. This luminaire must be installed in accordance with the NEC or your local electrical code. If you are not familiar with these codes and requirements, consult a qualified electrician.  
*Ce produit doit être installé conformément à NEC ou votre code électrique local. Si vous n'êtes pas familier avec ces codes et ces exigences, veuillez contacter un électricien qualifié.*
3. All electrical connections have been made at the factory.
4. The sensor is designed for mounting heights between 8 ft. to 40 ft. (2.4 m to 12.2 m), see figure 1, 2 and 3 for product specific coverage pattern. The handheld remote unit has a range of up to 40ft (12.2 m).
5. When mounting heights are above 30ft. (9.1 m), the sensor generally only detects large objects such as forklift trucks.
6. When the sensor lens assembly is removed the exposed sensor body is sensitive to electrostatic discharge. Take the necessary steps to avoid possible damage to the sensor.

### SAVE THESE INSTRUCTIONS FOR FUTURE REFERENCE

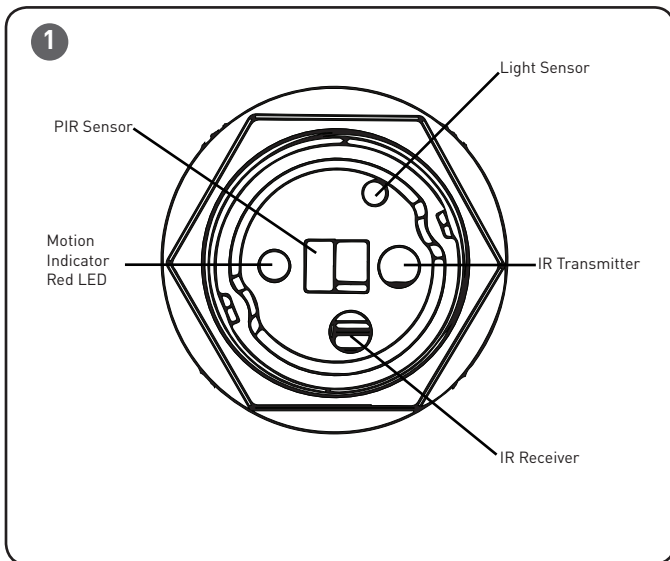

#### SENSOR DESCRIPTION

The FSP-2X1 is a motion sensor that controls lighting levels based on occupancy and ambient light. This slim, low-profile sensor is designed for installation inside the bottom of a light fixture body. The PIR lens module connects to the FSP-2X1 through a 1.30" diameter hole in the bottom of the fixture.

The sensors uses passive infrared (PIR) sensing technology that reacts to changes in infrared energy (moving body heat) within the coverage area. Once the sensor stops detecting movement and the time delay elapses, lights will go from high to low mode and eventually turn off if it is desired. Sensors must directly "see" motion of a person or moving object to detect them, so careful consideration must be given to sensor luminaire placement and lens selection. Avoid placing the sensor where obstructions may block the sensor's line of sight. See **Figure 1**.

The FSP-2X1 operates at 120V/230V/240V/277V/347V/480V, no power pack is required. It is designed to be installed in indoor and outdoor environments. Once the device is initially powered up, the FSP-2X1 will use factory default parameters to operate. If adjustments are needed, the programming tool must be used.



**2** FSP-L2 Low Density/Wide Range Lens

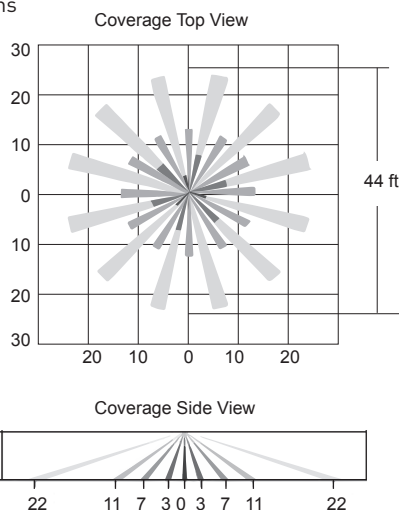
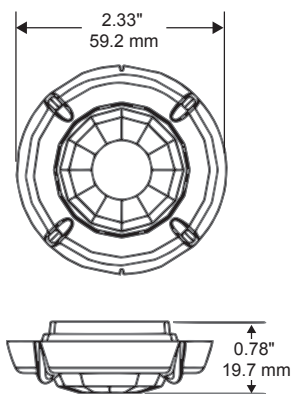

**3** FSP-L3 High Density/Reduced Range Lens

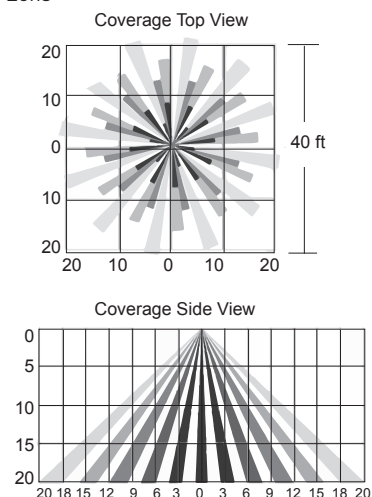
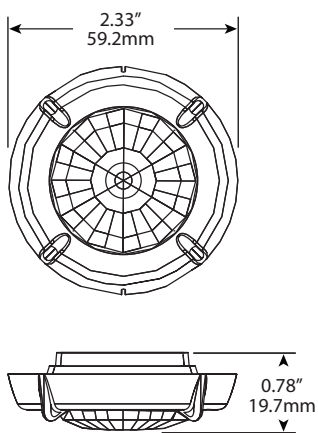

**4** FSP-L7 Wide Angle

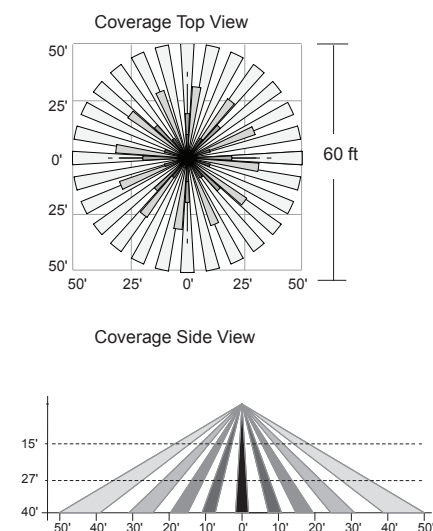
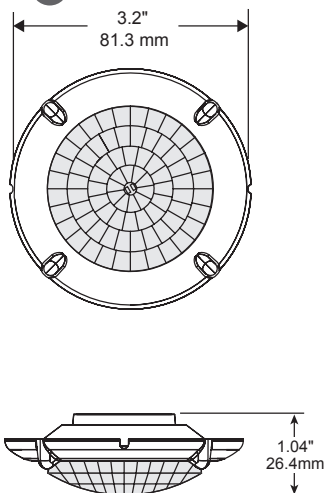

**INSTALLATION**

The FSP-2X1 unit comes pre-wired and installed in the fixture.

**NOTE:** Ensure that you remove the label on the unit that says, "Remove This Label Before Installing Lens". If this label is not removed, the sensor will not work properly.

**COVERAGE PATTERN**

The density and the range of the coverage pattern is determined by the type of lens and mounting height. For standard lenses and patterns for:

- FSP-L2: 360 ° Coverage - Provides a 44' (13.4 m) diameter coverage area when mounted at a height of 8' (2.4 m). See **Figure 2**.
- For FSP-L3: 360 ° Coverage - Has a high density lens that covers a 40' (12.2 m) diameter area at a height of 20' (6.1 m). See **Figure 3**.
- For FSP-L7: 360 ° Coverage - Provides a 100' (30.5m) diameter coverage area when mounted at a height of 40' (12.2m). See **Figure 4**.

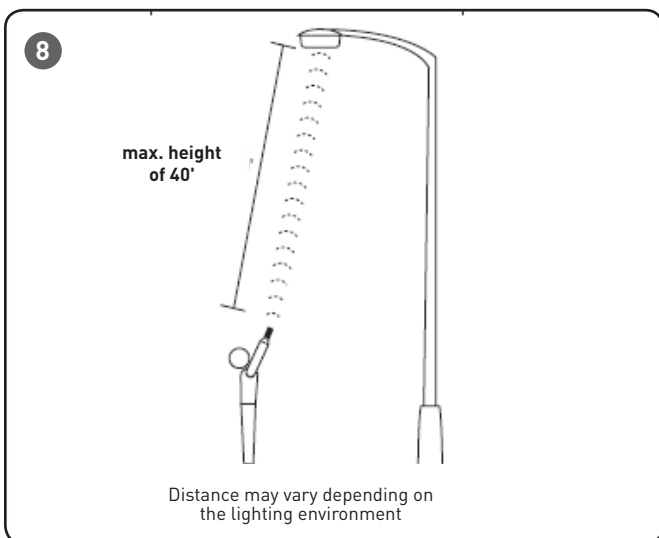
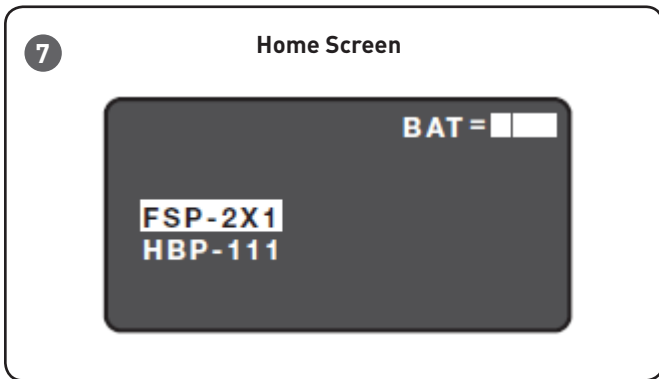
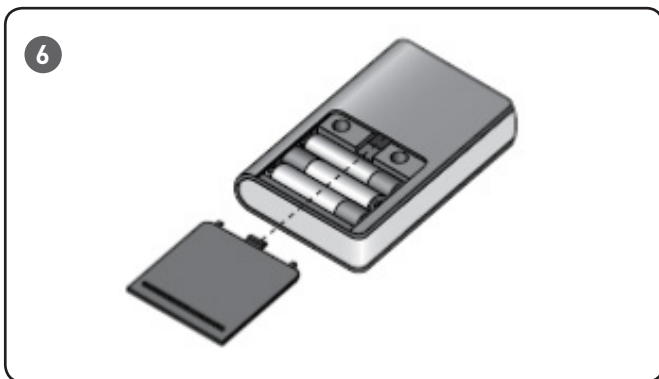
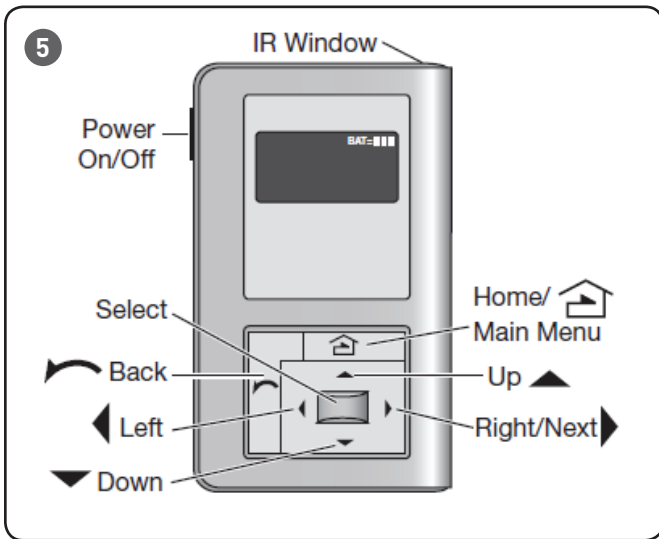

## FSP-2X1 COMMISSIONING

The commissioning process establishes the appropriate operating parameters of the FSP-2X1. This is done using the programming tool. If no commissioning steps are taken, the sensor will use its default parameter values. For default values see "Navigation of Programming Tool" section.

## USING THE PROGRAMMING TOOL

The Wireless IR Programming Tool is a handheld remote control for setup and testing of the FSP-2X1. It provides wireless access to change the parameters of the sensor.

The programming tool displays menus and prompts to lead you through each process. The navigation pad provides an intuitive way to navigate through the customization fields. See **Figure 5**.

Within a certain mounting height of the sensor, 40' (12.2m) or less, the programming tool allows modification of the system simply with the touch of a few buttons, without requiring ladders or tools.

## OPERATION

The programming tool's IR transceiver allows bi-directional communication between the FSP-2X1 and the remote control. Simple menu screens display the current status of the system and allow editing of the sensor parameters, such as high/low mode, sensitivity, time delay, cut off and more. You can also establish and store FSP-2X1 parameter profiles.

## BATTERIES

The programming tool operates on three standard 1.5V AAA Alkaline batteries or three rechargeable AAA NiMH batteries (See **Figure 6**). The battery status is shown in the upper right corner of the home screen (See **Figure 7**). Three bars next to BAT= indicates a full battery charge. A warning appears on the display when the battery charge falls below a minimum acceptable level. To conserve battery power, the programming tool automatically shuts off 10 minutes after the last key press.

## NAVIGATION

Use the (up) or (down) arrow keys to navigate from one field to another. The active field is indicated by a blinking cursor.

Once active, use the Select button to move to a menu or function within the active field. Value fields are used to adjust parameter settings. They are shown in angle brackets: <value>. Once active, change them using the (left) and (right) arrow keys. In general the (right) key increments and the (left) key decrements a value. Selections wrap-around if you continue to press the key beyond maximum or minimum values. Moving away from the value field overwrites the original value. The Home button takes you to the main menu. The Back button can be thought of as an undo function. It takes you back one screen. Changes that were in process prior to pressing the key are lost. See **Figure 5**.

## IR COMMUNICATION

IR communication can be affected by the mounting height of the sensor and high ambient lighting such as direct daylight or other electric light sources in close proximity

When trying to communicate with the FSP-2X1, be sure to be positioned directly under the sensor without any obstructions. Every time the programming tool establishes communication with the FSP-2X1, the controlled load will cycle. See **Figure 8**.

- If communication is not successful, (if possible) move closer to the sensor. In some cases, a ladder or lift may be required
- If still not successful, there may be too much IR interference from other sources. Programming the unit at night when there is no daylight available may be the only way to communicate with the sensor.
- If multiple FSP-2X1 sensors are within the transceiver's range, all of the loads may cycle and the "no response from device" message may appear on the display.

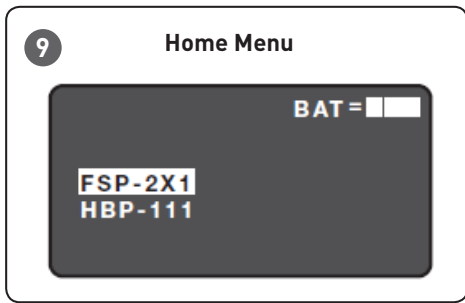

**HOME MENU**

The Home (or Main) menu displays after the power-up process completes. It contains information on the battery status and two menu choices. Press the (up) or (down) buttons to highlight the

desired sensor, then press **Select**. See **Figure 9**.

**NOTE:** Cree only uses the FSP-2X1 sensor. Do not select the HBP-111.

**NEW SETTINGS**

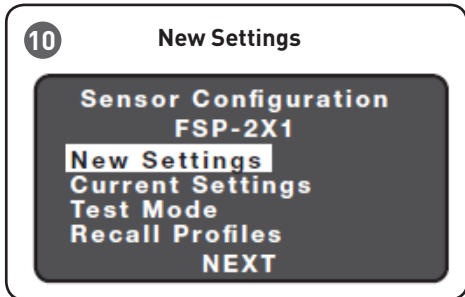

New Settings allow you to select the different sensor parameters such as: High/Low Mode, Time Delay, Cut Off, Sensitivity, Setpoint, Ramp/Fade rates and Photocell. See **Figure 10**.

**NOTE:** To move

faster when changing any of the values, press and hold the (left) or (right) keys.

**DEFAULT PARAMETER VALUES**

HIGH MODE:	10V
LOW MODE:	1V
TIME DELAY:	5 minutes
CUT OFF:	1 hour
SENSITIVITY:	Max
SETPOINT:	Disabled
RAMP UP:	Disabled; lights switch instantly
FADE DOWN:	Disabled; lights switch instantly
PHOTOCELL:	Disabled

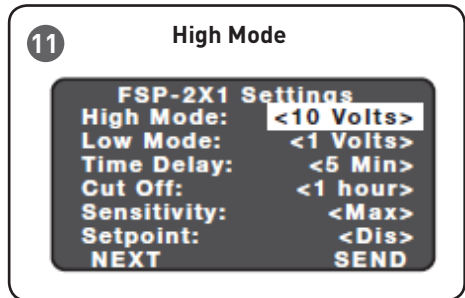

**HIGH MODE**

When the sensor detects motion the dimming control output ramps up to the selected HIGH light level (default is 10V). See **Figure 11**.

Range: 0 V to 10 V  
Increments: 0.2 V

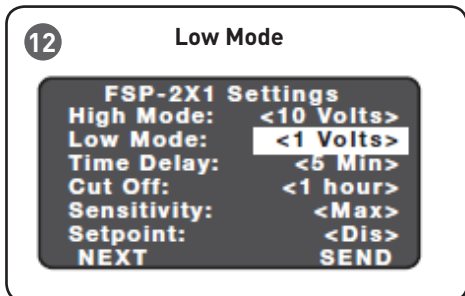

**LOW MODE**

After the sensor stops detecting motion and the time delay expires, the dimming control output fades down to the selected LOW light level (default is 1V). If OFF is selected, the controlled load will turn off. See **Figure 12**.

Range: OFF, 0 V to 9.8 V  
Increments: 0.2 V

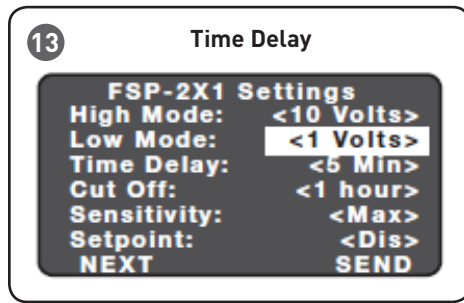

**TIME DELAY**

The time period that must elapse after the last time the sensor detects motion for the lights to fade to LOW mode (default is 5 minutes). See **Figure 13**.

Range: 30 sec, 1 min to 30 min  
Increments: 1 min

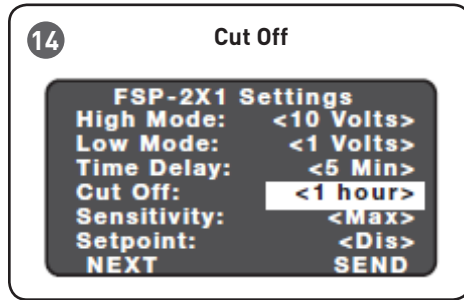

**CUT OFF**

The time period that must elapse after the lights fade to LOW mode and the sensor detects no motion for the lights to turn OFF (default is 1 hour). See **Figure 14**.

Range: None (the controlled load will stay in LOW mode until motion is detected) 1 min to 59 min, 1 hr to 5 hr  
Increments: 1 min or 1 hr

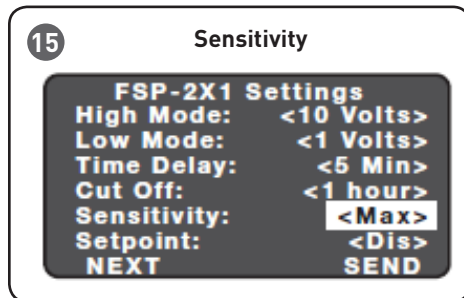

**SENSITIVITY**

The response of the PIR detector to motion within the sensor's coverage area (default is max). See **Figure 15**.

Range and Sequence: On-Fix, Off-Fix, Low, Med, Max

On-Fix: relay closed, load stays on with occupancy detection and photocell disabled;

Off-Fix: relay open, load stays off with occupancy detection disabled.

**NOTE:** On-Fix or Off-Fix settings are typically only used for testing or troubleshooting.

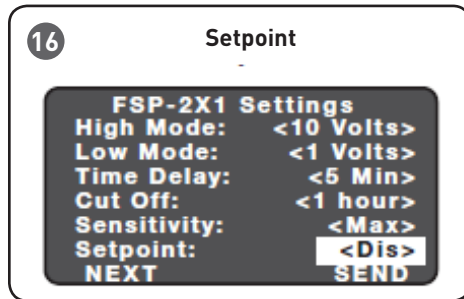

**SETPOINT**

When a numerical value is entered, the sensor will not respond to motion if the ambient light level is greater than the set point. Otherwise, if the light level is less than the set point, motion detection is

enabled. If LOW mode is set to OFF or if the Cut Off feature is enabled, then the luminaire will turn off and stay off until the light level falls below the set point. See **Figure 14**.

Range and Sequence: Auto, Disabled, 1 fc to 250 fc (11 to 2691 lux).  
Increments: 1 fc

The Auto option invokes an automatic calibration procedure to establish an appropriate setpoint based upon the contribution of the luminaire's own light. As part of this procedure, the controlled load is turned on for two minutes to warm up the lamp, and then it is switched off and on eight times, terminating in an off state. After this process, a new setpoint value is automatically calculated.

**NOTE:** The photocell setting will change to "disabled" after this procedure. If the photocell feature is desired, then a new value must be entered and sent to the sensor.

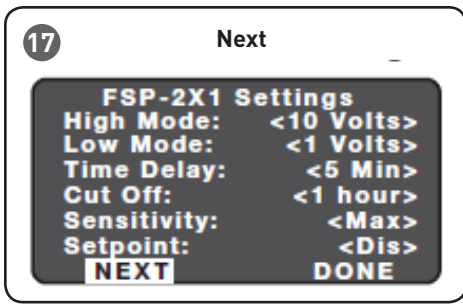

**NEXT**  
To view more settings go to NEXT and press the Select button. See Figure 17.

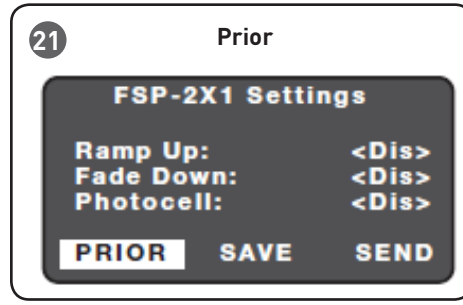

**PRIOR**  
To go back to previous settings go to PRIOR and press the Select button. See Figure 21.

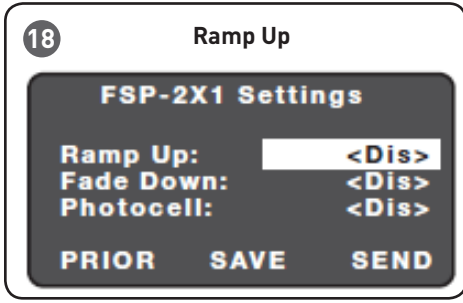

**RAMP UP**  
Time period for light level to increase from LOW to HIGH (default is none; lights switch instantly). See Figure 18.  
Range: Disabled, 1 sec to 60 sec  
Increments: 1 sec

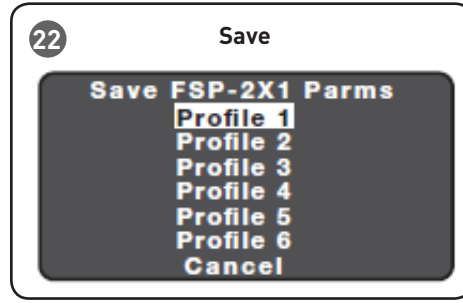

**SAVE**  
To save a set of parameters as one of the profiles go to SAVE and press the Select button. Then press the Up/Down arrow to choose Profile and press the Select button. See Figure 22.

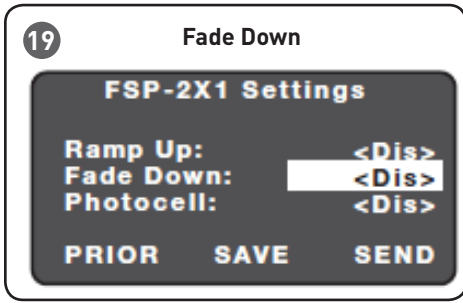

**FADE DOWN**  
Time period for light level to decrease from HIGH to LOW (default is none; lights switch instantly). See Figure 19.  
Range: Disabled, 1 sec to 60 sec  
Increments: 1 sec

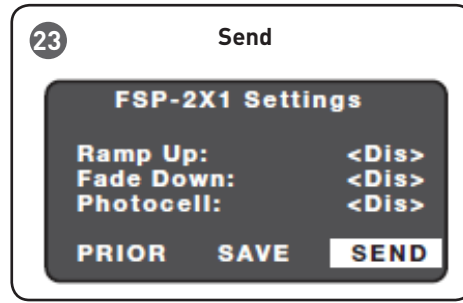

**SEND**  
To program the FSP-2X1 with the selected parameters, go to SEND and press the Select button. The controlled load should cycle once the sensor is programmed. If the "no response

from device" message appears, try again. To verify that the parameters were received, go to current settings. See Figure 23.

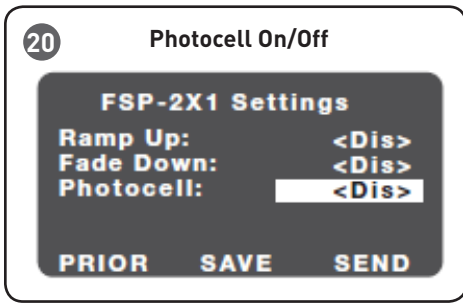

period of time (up to 2 minutes) to confirm that the light level increase is not temporary before forcing the lights to go off. This feature is disabled by default. When this setting is used in combination with the Setpoint feature, there must be at least 10fc (108 lux) of dead band between the two settings to help avoid load cycling. The programming tool will automatically set the photocell value to 10 fc above the setpoint value if the user attempts to enter two values that differ by less than 10 fc. See Figure 20.

Range and Sequence: Disabled, 1 fc to 250 fc (11 to 2691 lux)  
Increments: 1 fc (11 lux)

**\*NOTE:** older versions of the programming tool (prior to v2.36) call this setting "Off W/Occup". The version is shown when the remote control is first powered on.

**PHOTOCELL ON/OFF\***  
When the light level exceeds this setting, the lights will turn off even when the space is occupied. Once the light level exceeds this setting, the sensor will wait and monitor for a short

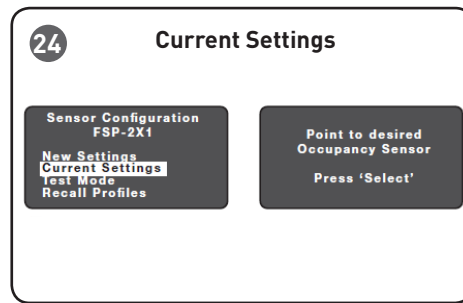

**CURRENT SETTINGS**  
Current Settings allow you to recall the parameters for a specific sensor. These are read only parameters. See Figure 24.

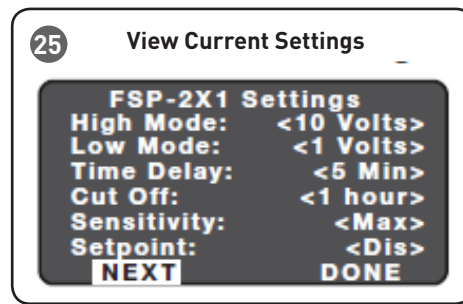

**VIEW CURRENT SETTINGS**  
Choose NEXT to view more settings or DONE to go back to the main menu. To go back to the previous screen, choose PRIOR. The recalled settings may be saved to a profile if desired. See Figure 25.

**LIGHT LEVEL**  
Present light level detected by the FSP-2X1. The light level reading can be used as a reference for setpoint adjustments.



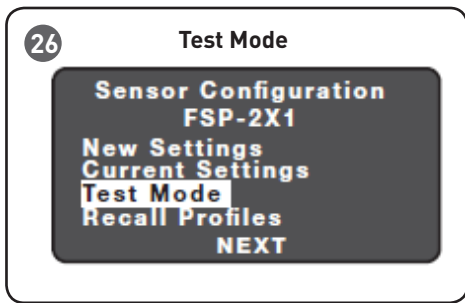

### TEST MODE

Test Mode shortens timeouts for High/Low and Cut Off, to allow for quick verification. Test Mode cancels automatically after 5 minutes. See **Figure 26**.

### ENABLE/DISABLE

Test Mode has been enabled.

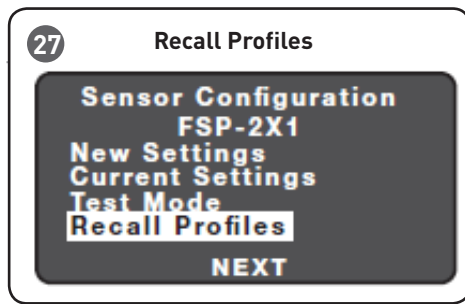

### RECALL PROFILES

Recall Profiles allow you to select the saved parameter profiles. This feature is useful for programming multiple sensors with the same parameters. See **Figure 27**.

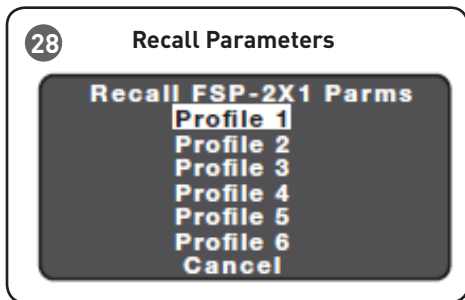

### RECALL PARAMETERS

Once a profile is selected, the parameters can be sent to the sensor or they can be modified and then sent. If the parameters are modified, the changes will not be

saved to the selected profile unless SAVE is chosen. See **Figure 28**.

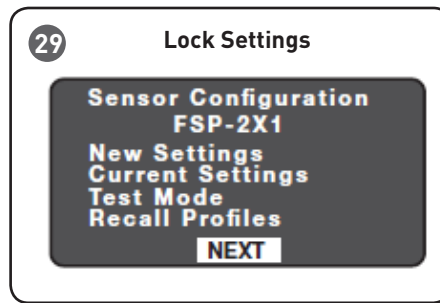

### LOCK SETTINGS

IR communication locks to prevent unauthorized changes of FSP-2X1 parameters.

**NOTE:** This security feature restricts access to the FSP-2X1 to authorized installers who have access to the AC mains supply.

To view more sensor configuration settings go to NEXT and press the Select button. Press Select to set Lock Delay or press PRIOR to go back. See **Figure 29 and 30**.

The FSP-2X1 lock delay is set to disabled by default. To enable Lock Delay with time, enter a value in the field and press SEND to set delay time in the FSP-2X1. Parameter changes cannot be made with the remote control after the specified time period expires, and the FSP-2X1 will remain locked unless there is a power cycle. Power must be cycled to unlock the sensor and make changes with a remote control. To permanently disable Lock Delay after power cycling, select Disable and press SEND. See **Figure 31 and 32**.

Range: 10 min - 240 min  
Increments: 1 min

The screen shown in **Figure 33** will appear if the FSP-2X1 is locked. If it is locked, cycle the power.

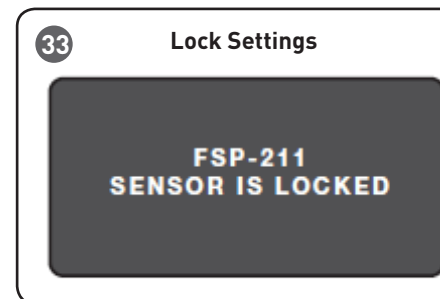
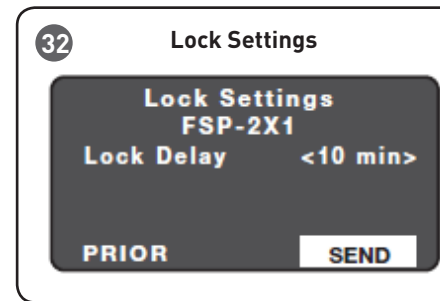
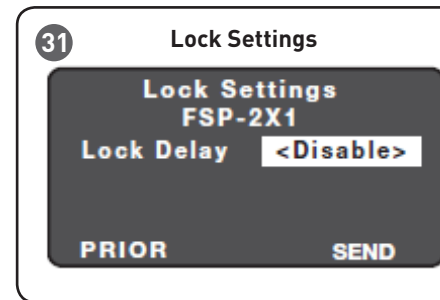
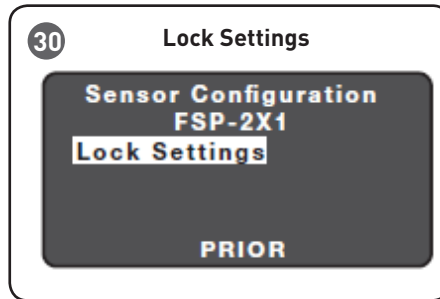

## PROGRAMMING EXAMPLES AND TIPS

### Outdoor installation using Setpoint and Photocell features

High Mode	8.0 Volts
Low Mode	2.4 Volts
Time Delay	5 min
Cut Off	Dis
Sensitivity	Med
Setpoint	15
Ramp Up	Dis
Fade Down	Dis
Photocell	30

This configuration will set the luminaire to turn on at dusk when the ambient light level drops below 15 fc (161 lx). When motion is detected, the luminaire will switch to high mode. If after 5 minutes no motion is detected, then it will switch to low mode. If the ambient light level is greater than 15 fc but less than 30 fc (322 lx), then the luminaire will stay in low mode, even if motion is detected. When the ambient light level rises above 30 fc, then the luminaire will turn off and remain off until the light level drops back below 15 fc.

Tip: It may be necessary to adjust the setpoint and photocell values to compensate for reflected light from the luminaire or adjacent light sources. Check the light level by reading the current settings using the programming tool. If the light level is higher than the photocell value, the luminaire will turn off. If this behavior is not desired, then increase the photocell value. If the luminaire is staying in low mode, then it may be necessary to increase the setpoint value.

Tip: When checking light level, wait ~5 seconds after a sudden change in light level (e.g. luminaire switching from high to low mode). It may be necessary to take more than one reading.

### Indoor installation with Cut Off

High Mode	10 Volts
Low Mode	5.0 Volts
Time Delay	2 min
Cut Off	5 min
Sensitivity	High
Setpoint	Dis=
Ramp Up	Dis
Fade Down	5 sec
Photocell	Dis

In this configuration the luminaire dim to low mode with a 5-second fade down after 2 minutes elapse with no motion detection. After 5 minutes, the luminaire will turn off. When motion is detected, the luminaire will switch to high mode. The luminaire will not be affected by the ambient light level.

## TROUBLESHOOTING

### NO RESPONSE SCREEN APPEARS:

- Make sure that the sensor is not obstructed.
- Move closer to the sensor. A ladder or lift may be required.
- The angle may be too high, move closer so that you are directly underneath the sensor.
- Make sure that multiple sensors are not in the range of the transceiver. If this happens, then all of the luminaires will cycle.

- If still not successful, there may be too much IR interference from other sources. Programming the unit at night may be the only way to communicate with the sensor.

### LIGHTS WILL NOT GO TO HIGH MODE:

- Make sure that the sensor is not obstructed. The sensor must detect motion to switch to HIGH mode. The red LED indicator will blink when motion is detected.
- Check the light level parameter, to find out the amount of light that the sensor is detecting. Cover the sensor lens to simulate darkness in the room. If the luminaire goes to high mode, then the setpoint needs to be adjusted to a value greater than the detected light level. See the new settings and current settings sections for instructions.
- If the light level is higher than the setpoint value but less than the photocell value, then the luminaire will remain in low mode. Adjust the setpoint and photocell values as needed.
- Make sure that the high and low settings are correct by checking the current settings.

### LIGHTS WILL NOT GO INTO LOW MODE:

The time delay can be set from a minimum of 30 seconds to a maximum of 30 minutes. Ensure that the time delay is set to the desired value and that there is no movement within the sensor's view for that time period.

- To quickly test the unit operation, enable Test Mode and move out of the sensor's view. The luminaire should go to LOW mode after 5 seconds.

### LIGHTS WILL NOT TURN OFF:

- Cut Off time may be set to "None."
- Ensure that the Cut Off is set to the desired time and that there is no movement within the sensor's view for that time period when the lights are in Low Mode.
- To quickly test the unit operation, enable test mode and move out of the sensor's view. The luminaire should switch to LOW mode after 5 seconds and then turn OFF (if cut off is enabled) after 10 sec.
- If the luminaire does not turn off in daylight, check the ambient light level. Adjust the photocell setting to a value lower than the ambient light level. The setpoint may also need to be adjusted if the difference is less than 10 fc.
- Make sure that the Sensitivity field is not set to On-Fix.

### LIGHTS WILL NOT TURN ON:

- Check all wire connections and verify that the load and the ground wires are tightly secured.
- Check the current settings. If the setpoint value is lower than the ambient light level, the luminaire will be held OFF. Increase the setpoint value.
- Disable the cut off function, if not desired.
- Make sure that the Sensitivity field is not set to Off-Fix.

## OPERATION DURING POWER-UP

During the sensor warm-up period, which can last up to a minute after initial power-up (or after a lengthy power outage), the load will remain ON until the selected time delay expires.

## TECHNICAL SUPPORT

If unable to successfully resolve problems with the sensor, call 800.236.6800 for Cree technical support.