

# RSW Series

RSW™ LED Street Luminaire – Large

Rev. Date: V8 04/23/2020

## Product Description

The RSW Series, utilizing WaveMax® Technology, will transform the way utilities and municipalities light their residential streets, interchanges, and expressways. With the first viable LED streetlight at warm CCT, the RSW Series delivers up to 119 LPW, enhanced visual comfort with reduced glare and high color contrast leading to improved overall illumination using less energy. The RSW Series provides warm, inviting dark sky friendly lighting that makes good economic sense.

**Applications:** Collector roads, major roads, parking lots, and general area spaces

## Performance Summary

Utilizes WaveMax® Technology

Assembled in the U.S.A. of U.S. and imported parts

**Initial Delivered Lumens:** Up to 14,575

**Efficacy:** Up to 119 LPW

**CRI:** Minimum 70 CRI

**CCT:** 3000K, 4000K, 5000K

**Limited Warranty†:** 10 years

\* See <http://creelighting.com/warranty> for warranty terms

## Accessories

Field-Installed	
<b>Backlight Control Shield</b> RSW-BLSL - Provides 1 mounting height cutoff - 0.5" (13mm) 301 stainless steel construction - Refer to initial delivered lumen tables for lumen output	<b>Shorting Cap</b> XA-XLSHRT

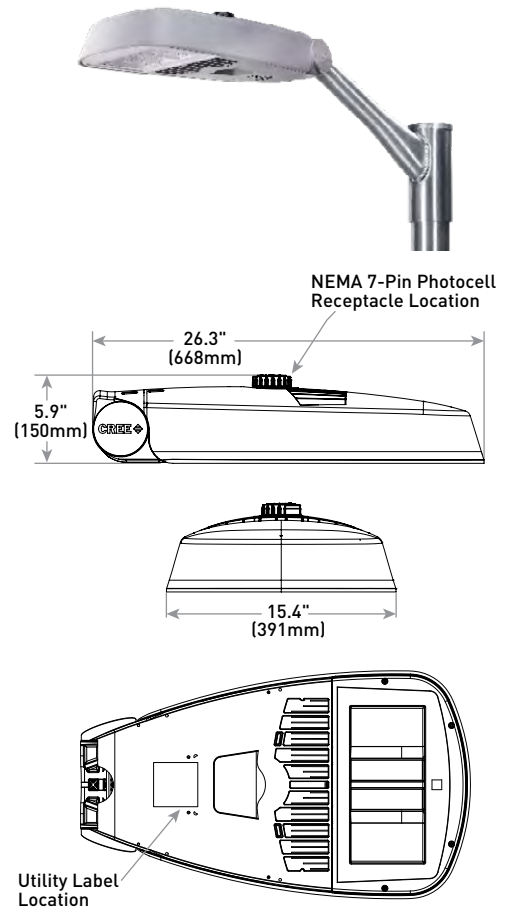

Weight*
20.2 lbs. (9.2kg)

\*RSW-BLSL Accessory: add 0.6 lbs. (0.3kg)

## Ordering Information

Example: RSWL-A-HT-2ME-14L-30K7-UL-GY-N

RSWL	A	HT		14L				N	
Product	Version	Mounting	Optic	Lumen Package**	CCT/CRI	Voltage	Color Options	Utility Label/Receptacle	Options
RSWL Large	A	HT Horizontal Tenon	2LG* Type II Long 2ME* Type II Medium 3ME* Type III Medium	14L 14,000 Lumens	30K7 3000K, 70 CRI 40K7 4000K, 70CRI 50K7 5000K, 70CRI	UL 120-277V UH 347-480V	BK Black BZ Bronze GY Grey	N Utility Label and NEMA® 7-Pin Photocell Receptacle - External wattage label per ANSI C136.15 - 7-pin receptacle per ANSI C136.41 - Factory connected 0-10V dim leads - Requires photocell or shorting cap by others	4BLT Four Bolt Mounting - Mounts to 1.25" [32mm] IP, 1.66" [42mm] O.D. or 2" [51mm] IP, 2.375" [60mm] O.D. horizontal tenon PP Pallet Packaging - Multiple luminaires (up to 14 maximum per pallet) Q9/Q8/Q7/Q6/Q5/Q4/Q3/Q2/Q1 Field Adjustable Lumen Output - Must select Q9, Q8, Q7, Q6, Q5, Q4, Q3, Q2, or Q1 - Offers full range lumen adjustability - Includes wattage label for setting selected - Refer to page 5 for power and lumen values - Luminaire may also be dimmed through 7-Pin receptacle with use of dimming control by others - Refer to <a href="#">dimming spec sheet</a> for dimming multipliers SS Stainless Steel Bolts X8/X7/X6/X5/X4/X3/X2/X1 Locked Lumen Output - Must select X8, X7, X6, X5, X4, X3, X2, or X1 - Lumen output is permanently locked to the setting selected - Includes wattage label for setting selected - Refer to page 5 for power and lumen values - Dimming is only available through 7-Pin receptacle with use of dimming control by others - Refer to <a href="#">dimming spec sheet</a> for dimming multipliers

\* Available with Backlight Shield when ordered with field-installed accessory (see table above)

\*\* Lumen Package codes identify approximate light output only. Actual lumen output levels vary depending on CCT and optic selection. Refer to Initial Delivered Lumen tables for specific lumen values



**CREE LIGHTING**

US: [creelighting.com](http://creelighting.com) (800) 236-6800

Canada: [creelighting-canada.com](http://creelighting-canada.com) (800) 473-1234

**Product Specifications**

**WAVEMAX® TECHNOLOGY**

Featuring up to 90% optical efficiency and precise control, WaveMax® Technology provides unmatched comfort and decreased LED source luminance by smoothly spreading brightness over a broader area. When integrated with luminous surfaces made of a polymer medium engineered with DiamondFacet™ optical elements, extremely high efficacy luminaires are the result – ultimately creating more visually comfortable and appealing environments while exceeding illumination performance.

**CONSTRUCTION & MATERIALS**

- Housing constructed of high strength, lightweight bulk molding compound for long weathering and durability
- UV stabilized polymeric door with handle pocket for tool-less entry
- Straight in wiring to terminal block for power input (#6-#14 AWG)
- Optic box and driver enclosure inside optic box meet IP66 requirements
- Mounts on 1.25" [32mm] IP, 1.66" [42mm] O.D. or 2" [51mm] IP, 2.375" [60mm] O.D. horizontal tenon (minimum 8" [203mm] in length) and is adjustable +/- 5° in 2.5° increments to allow for fixture leveling (two axis T-level included)
- Luminaire secures with two grade 5 steel mounting bolts w/clear zinc clad finish standard; optional 316 stainless steel mounting bolts available with SS option. Optional four bolt mounting is also available
- Comes standard with Utility Label per ANSI C136.15 and 7-pin NEMA® Photocell Receptacle per ANSI C136.41
- **Weight:** 20.2 lbs. (9.2kg); add 0.6 lbs. (0.3kg) for RSW-BLSL accessory

**ELECTRICAL SYSTEM**

- **Input Voltage:** 120-277V or 347-480V, 50/60Hz, Class 1 drivers
- **Power Factor:** > 0.9 at full load
- **Total Harmonic Distortion:** < 20% at full load
- Integral 10kV surge suppression protection standard
- When code dictates fusing, a slow blow fuse or type C/D breaker should be used to address inrush current
- **10V Source Current:** 0.15mA
- **Operating Temperature Range:** -40°C - +40°C [-40°F - + 104°F]

**REGULATORY & VOLUNTARY QUALIFICATIONS**

- cULus Listed
- Suitable for wet locations
- Certified to ANSI C136.31-2001, 3G bridge and overpass vibration standards
- Meets CALTrans 611 Vibration testing
- ANSI C136.2 10kV surge protection, tested in accordance with IEEE/ANSIC62.41.2
- Meets FCC Part 15, Subpart B, Class A limits for conducted and radiated emissions
- Meets Buy American requirements within ARRA
- RoHS compliant. Consult factory for additional details
- Dark Sky Friendly, IDA Approved when ordered with 30K CCT. Please refer to <https://www.darksky.org/our-work/lighting/lighting-for-industry/fsa/fsa-products/> for most current information
- DLC and DLC Premium qualified versions available when ordered with UL voltage. Please refer to <https://www.designlights.org/search/> for most current information
- **CA RESIDENTS WARNING:** Cancer and Reproductive Harm – [www.p65warnings.ca.gov](http://www.p65warnings.ca.gov)

**Product Specifications**

**SYNAPSE® SIMPLYSNAP INTELLIGENT CONTROL**

**FOR NON-STREET LIGHTING APPLICATIONS ONLY**

The RSW Series is compatible with the Synapse® SimplySNAP platform. A highly intuitive connected lighting solution for Site and Area applications only. The system features a reliable and robust self-healing mesh network with a browser-based interface that runs on smartphones, tablets, and PCs. Using a Twist-Lock Lighting Controller and Site Controller, SimplySnap provides: energy productivity, code compliance and a better light experience for non-street lighting installations. SimplySNAP is optimized to create and manage networks for campus wide Area and Site applications which differs from networking requirements for street lighting applications.

Synapse Wireless Control Accessories (for Non-Street Lighting Applications only)	
<b>Twist-Lock Lighting Controller</b> TL7-B2 - Suitable for 120-277V (UL) voltage only - Requires NEMA/ANSI C136.41 7-Pin Dimming Receptacle - Not for use with Q options - Provides On/Off switching, dimming, power metering, digital sensor input, and status monitoring of luminaires - Refer to <a href="#">TL7-B2</a> spec sheet for details	<b>SimplySNAP On-Site Controller</b> SS450-002 - Verizon® LTE-enabled - Designed for indoor applications - Refer to <a href="#">SS450-002</a> spec sheet for details <b>Building Management System (BMS) Gateway</b> BMS-GW-002 - Required for BACnet integration - Refer to <a href="#">BMS-GW-002</a> spec sheet for details <b>Outdoor Antennas</b> (Optional, for increased range, 8dB gain) KIT-ANT420SM - Kit includes antenna, 20' cable and bracket KIT-ANT360 - Kit includes antenna, 30' cable and bracket KIT-ANT600 - Kit includes antenna, 50' cable and bracket - Refer to <a href="#">Outdoor antenna spec sheet</a> for details
<b>SimplySNAP Central Base Station</b> CBS5W-450-002 - Includes On-Site Controller (SS450-002) and 5-button switch - Indoor and Outdoor rated - Refer to <a href="#">CBS5W-450-002</a> spec sheet for details <b>Synapse Wireless Sensor</b> WSN-DPM - Motion and light sensor - Control multiple zones - Refer to <a href="#">WSN-DPM</a> spec sheet for details	

Electrical Data*										
Lumen Output	CCT/ CRI	System Watts 120-480V	Utility Label Wattage	Efficacy (LPW)	Total Current (A)					
					120V	208V	240V	277V	347V	480V
14L	30K7	136	140	107	1.16	0.65	0.57	0.49	0.40	0.28
	40K7	122	120	119	1.04	0.59	0.51	0.45	0.36	0.25
	50K7	122	120	119	1.04	0.59	0.51	0.45	0.36	0.25

\* Electrical data at 25°C (77°F). Actual wattage may differ by +/- 10% when operating between 120-277V or 347-480V +/- 10%

RSW Series (RSWL) Series Ambient Adjusted Lumen Maintenance <sup>1</sup>					
Ambient	Initial LMF	25K hr Reported <sup>2</sup> LMF	50K hr Reported <sup>2</sup> LMF	75K hr Reported <sup>2</sup> LMF	100K hr Estimated <sup>3</sup> LMF
5°C (41°F)	1.04	1.03	1.02	1.02	1.02
10°C (50°F)	1.03	1.02	1.01	1.01	1.01
15°C (59°F)	1.02	1.01	1.00	1.00	1.00
20°C (68°F)	1.01	1.00	0.99	0.99	0.98
25°C (77°F)	1.00	0.98	0.98	0.98	0.97

<sup>1</sup> Lumen maintenance values at 25°C (77°F) are calculated per IES TM-21 based on IES LM-80 report data for the LED package and in-situ luminaire testing. Luminaire ambient temperature factors (LATF) have been applied to all lumen maintenance factors. Please refer to the [Temperature Zone Reference Document](#) for outdoor average nighttime ambient conditions.

<sup>2</sup> In accordance with IES TM-21, Reported values represent interpolated values based on time durations that are up to 6x the tested duration in the IES LM-80 report for the LED.

<sup>3</sup> Estimated values are calculated and represent time durations that exceed the 6x test duration of the LED.

**Photometry**

All published luminaire photometric testing performed to IES LM-79-08 standards. To obtain an IES file specific to your project consult: <https://creelighting.com/products/outdoor/street-and-roadway/rsw-series>

**2LG**

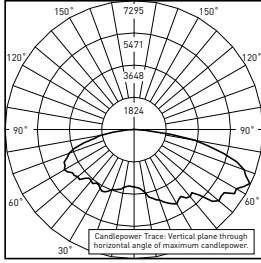

**UL Verification Services Test Report #:** 12081584.03A  
**RSWL-A\*\*-2LG-14L-30K7-UL-GY-N**  
**Initial Delivered Lumens:** 14,315

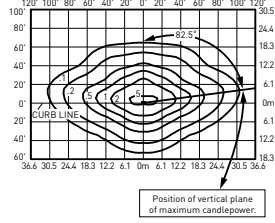

**RSWL-A\*\*-2LG-14L-30K7-UL-GY-N**  
**Mounting Height:** 25' (7.6m) A.F.G.  
**Initial Delivered Lumens:** 14,575  
**Initial FC at grade**

**Type II Long Distribution**

Lumen Package*	CRI	3000K/4000K/5000K	
		Initial Delivered Lumens*	BUG Ratings** Per TM-15-11
14L	70	14,575	B3 U0 G3

\* Initial delivered lumens at 25°C (77°F). Actual production yield may vary between -10 and +10% of initial delivered lumens  
 \*\* For more information on the IES BUG (Backlight-Uplight-Glare) Rating visit: <https://www.ies.org/wp-content/uploads/2017/03/TM-15-11BUGRatingsAddendum.pdf>. Valid with no tilt

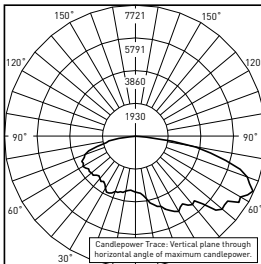

**UL Verification Services Test Report #:** 12081584.06A  
**RSWL-A\*\*-2LG-14L-30K7-UL-GY-N w/RSW-BLSL**  
**Initial Delivered Lumens:** 12,953

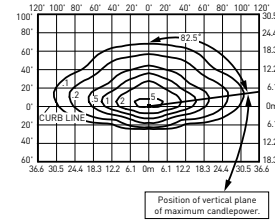

**RSWL-A\*\*-2LG-14L-30K7-UL-GY-N w/RSW-BLSL**  
**Mounting Height:** 25' (7.6m) A.F.G.  
**Initial Delivered Lumens:** 12,875  
**Initial FC at grade**

**Type II Long w/BLS Distribution**

Lumen Package*	CRI	3000K/4000K/5000K	
		Initial Delivered Lumens*	BUG Ratings** Per TM-15-11
14L	70	12,875	B2 U0 G3

\* Initial delivered lumens at 25°C (77°F). Actual production yield may vary between -10 and +10% of initial delivered lumens  
 \*\* For more information on the IES BUG (Backlight-Uplight-Glare) Rating visit: <https://www.ies.org/wp-content/uploads/2017/03/TM-15-11BUGRatingsAddendum.pdf>. Valid with no tilt

**2ME**

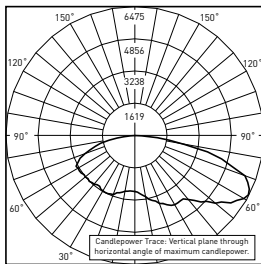

**UL Verification Services Test Report #:** 12081584.01A  
**RSWL-A\*\*-2ME-14L-30K7-UL-GY-N**  
**Initial Delivered Lumens:** 14,298

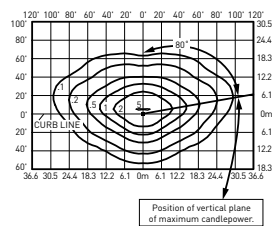

**RSWL-A\*\*-2ME-14L-30K7-UL-GY-N w/RSW-BLSL**  
**Mounting Height:** 25' (7.6m) A.F.G.  
**Initial Delivered Lumens:** 14,575  
**Initial FC at grade**

**Type II Medium Distribution**

Lumen Package*	CRI	3000K/4000K/5000K	
		Initial Delivered Lumens*	BUG Ratings** Per TM-15-11
14L	70	14,575	B3 U0 G3

\* Initial delivered lumens at 25°C (77°F). Actual production yield may vary between -10 and +10% of initial delivered lumens  
 \*\* For more information on the IES BUG (Backlight-Uplight-Glare) Rating visit: <https://www.ies.org/wp-content/uploads/2017/03/TM-15-11BUGRatingsAddendum.pdf>. Valid with no tilt

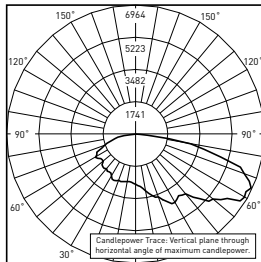

**UL Verification Services Test Report #:** 12081584.05A  
**RSWL-A\*\*-2ME-14L-30K7-UL-GY-N w/RSW-BLSL**  
**Initial Delivered Lumens:** 12,878

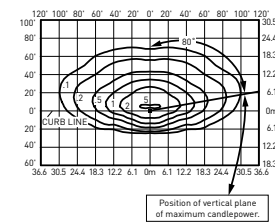

**RSWL-A\*\*-2ME-14L-30K7-UL-GY-N w/RSW-BLSL**  
**Mounting Height:** 25' (7.6m) A.F.G.  
**Initial Delivered Lumens:** 12,875  
**Initial FC at grade**

**Type II Medium w/BLS Distribution**

Lumen Package*	CRI	3000K/4000K/5000K	
		Initial Delivered Lumens*	BUG Ratings** Per TM-15-11
14L	70	12,875	B2 U0 G3

\* Initial delivered lumens at 25°C (77°F). Actual production yield may vary between -10 and +10% of initial delivered lumens  
 \*\* For more information on the IES BUG (Backlight-Uplight-Glare) Rating visit: <https://www.ies.org/wp-content/uploads/2017/03/TM-15-11BUGRatingsAddendum.pdf>. Valid with no tilt

# RSW™ LED Street Luminaire – Large

## Photometry

All published luminaire photometric testing performed to IES LM-79-08 standards. To obtain an IES file specific to your project consult: <https://creelighting.com/products/outdoor/street-and-roadway/rsw-series>

### 3ME

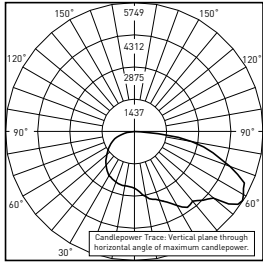

**UL Verification Services Test Report #:** 12081584.04A  
**RSWL-A-\*\*-3ME-14L-30K7-UL-GY-N**  
**Initial Delivered Lumens:** 14,127

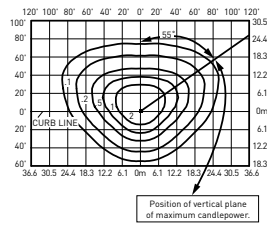

**RSWL-A-\*\*-3ME-14L-30K7-UL-GY-N**  
**Mounting Height:** 25' (7.6m) A.F.G.  
**Initial Delivered Lumens:** 14,575  
**Initial FC at grade**

Type III Medium Distribution			
Lumen Package*	CRI	3000K/4000K/5000K	
		Initial Delivered Lumens*	BUG Ratings** Per TM-15-11
14L	70	14,575	B3 U0 G3

\* Initial delivered lumens at 25°C (77°F). Actual production yield may vary between -10 and +10% of initial delivered lumens  
 \*\* For more information on the IES BUG (Backlight-Uplight-Glare) Rating visit: <https://www.ies.org/wp-content/uploads/2017/03/TM-15-11BUGRatingsAddendum.pdf>. Valid with no tilt

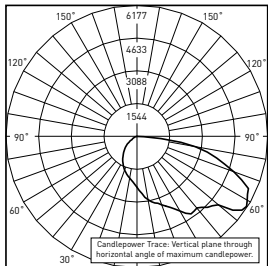

**UL Verification Services Test Report #:** 12081584.07A  
**RSWL-A-\*\*-3ME-14L-30K7-UL-GY-N w/RSW-BLSL**  
**Initial Delivered Lumens:** 12,786

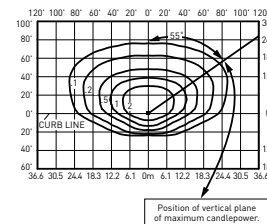

**RSWL-A-\*\*-3ME-14L-30K7-UL-GY-N w/RSW-BLSL**  
**Mounting Height:** 25' (7.6m) A.F.G.  
**Initial Delivered Lumens:** 12,875  
**Initial FC at grade**

Type III Medium Distribution w/BLS Distribution			
Lumen Package*	CRI	3000K/4000K/5000K	
		Initial Delivered Lumens*	BUG Ratings** Per TM-15-11
14L	70	12,875	B2 U0 G3

\* Initial delivered lumens at 25°C (77°F). Actual production yield may vary between -10 and +10% of initial delivered lumens  
 \*\* For more information on the IES BUG (Backlight-Uplight-Glare) Rating visit: <https://www.ies.org/wp-content/uploads/2017/03/TM-15-11BUGRatingsAddendum.pdf>. Valid with no tilt

## Luminaire EPA

Horizontal Tenon Mount – Weight: 20.2 lbs. (9.2kg); RSW-BLSL Accessory: add 0.6 lbs. (0.3kg)					
Luminaire	Single	2 @ 90°	2 @ 180°	3 @ 90°	4 @ 90°
<b>Tenon Configuration</b> If used with Cree Lighting tenons, please add tenon EPA with luminaire EPA					
Standard Luminaire	1.00	1.55	2.00	2.55	3.10
Luminaire w/RSW-BLSL Accessory	1.01	2.16	2.01	3.17	4.33

## Tenon EPA

Part Number	EPA
PD Series Tenons	0.09
PT Series Tenons	0.10
WM-2L	0.13
XA-TMDA8	0.19

Tenons and Brackets* (must specify color)	
<b>Square Internal Mount Horizontal Tenons (Aluminum)</b> - Mounts to 4" (102mm) square aluminum or steel poles PD-1H4 – Single PD-2H4(90) – 90° Twin PD-2H4(180) – 180° Twin PD-3H4(90) – 90° Triple PD-4H4(90) – 90° Quad	<b>Round External Mount Horizontal Tenons (Aluminum)</b> - Mounts to 2.375"-3" (60-76mm) O.D. round aluminum or steel poles or tenons PT-1H – Single PT-2H(90) – 90° Twin PT-2H(180) – 180° Twin PT-3H(90) – 90° Triple PT-4H(90) – 90° Quad
<b>Wall Mount Brackets</b> - Mounts to wall or roof WM-2L – Extended Horizontal	<b>Direct Arm Pole Adaptor Bracket</b> - Mounts to 3-6" (76-152mm) round or square aluminum or steel poles XA-TMDA8

\* Refer to the [Bracket and Tenons spec sheet](#) for more details

**Field Adjustable Output (Q9/Q8/Q7/Q6/Q5/Q4/Q3/Q2/Q1) Option Description:**

The Field Adjustable Output option enables the street and area luminaire within the RSW Series on this page to be tuned to the exact needs of a particular application through multiple levels of adjustment. When ordered with the Q option, the luminaire will be shipped from the factory at the selected lumen output, will be fully adjustable between the outputs, and will include a wattage label that indicates the wattage of the luminaire at the selected lumen output (Rounded to nearest 10 watts per ANSI C136.15-2015.). Additional dimming functionality is available when a dimming control (by others) is used in the 7-Pin receptacle.

**Locked Lumen Output (X8/X7/X6/X5/X4/X3/X2/X1) Option Description:**

The Locked Lumen Output option on this page permanently locks the lumen output on the RSW Series street and area luminaire to the setting selected. When ordered with the X option, the luminaire will be shipped from the factory at the lumen output setting selected, and will include a wattage label that indicates the wattage of the setting selected. When this option is selected, the luminaire output is not able to be adjusted in the field except if a dimming control (by others) is used in the 7-Pin receptacle.

**Q & X Option Power & Lumen Data – 14L**

Q Option Setting	X Option Setting	CCT/CRI	System Watts <sup>†</sup>		Lumen Values <sup>†</sup>		Optics Qualified on DLC QPL	
			120-480V	Label Wattage	2LG, 2ME & 3ME	w/BLS	Standard	Premium
Q9 (Full Power)	N/A (Full Power)	30K7	136	140	14,575	12,875	2LG, 2ME, 3ME	
		40K7	122	120			2LG, 2ME, 3ME	
		50K7	122	120				2LG, 2ME, 3ME
Q8	X8	30K7	133	130	14,425	12,725	2LG, 2ME, 3ME	
		40K7	119	120			2LG, 2ME, 3ME	
		50K7	119	120				2LG, 2ME, 3ME
Q7	X7	30K7	126	130	13,850	12,225	2LG, 2ME, 3ME	
		40K7	112	110			2LG, 2ME, 3ME	
		50K7	112	110				2LG, 2ME, 3ME
Q6	X6	30K7	120	120	13,400	11,825	2LG, 2ME, 3ME	
		40K7	108	110			2LG, 2ME, 3ME	
		50K7	108	110				2LG, 2ME, 3ME
Q5	X5	30K7	110	110	12,375	10,925	2LG, 2ME, 3ME	
		40K7	99	100			2LG, 2ME, 3ME	
		50K7	99	100				2LG, 2ME, 3ME
Q4	X4	30K7	102	100	11,575	10,225	2LG, 2ME, 3ME	
		40K7	92	90			2LG, 2ME, 3ME	
		50K7	92	90				2LG, 2ME, 3ME
Q3	X3	30K7	90	90	10,500	9,275	2LG, 2ME, 3ME	
		40K7	81	80			2LG, 2ME, 3ME	
		50K7	81	80				2LG, 2ME, 3ME
Q2	X2	30K7	81	80	9,250	8,175	2LG, 2ME, 3ME	
		40K7	72	70			2LG, 2ME, 3ME	
		50K7	72	70				2LG, 2ME, 3ME
Q1	X1	30K7	70	70	8,350	7,375	2LG, 2ME, 3ME	
		40K7	62	60			2LG, 2ME, 3ME	
		50K7	62	60				2LG, 2ME, 3ME

<sup>†</sup> Electrical and lumen data at 25°C (77°F). Actual wattage and lumen output may differ by +/-10% when operating between 120-277V or 347-480V +/-10%