

RSW Series

RSW™ LED Street Luminaire – Medium

Rev. Date: V9 04/23/2020

Product Description

The RSW Series, utilizing WaveMax® Technology, will transform the way utilities and municipalities light their residential streets, interchanges, and expressways. With the first viable LED streetlight at warm CCT, the RSW Series delivers up to 121 LPW, enhanced visual comfort with reduced glare and high color contrast leading to improved overall illumination using less energy. The RSW Series provides warm, inviting dark sky friendly lighting that makes good economic sense.

Applications: Residential roads, collector roads, parking lots, and general area spaces

Performance Summary

Utilizes WaveMax® Technology

Assembled in the U.S.A. of U.S. and imported parts

Initial Delivered Lumens: Up to 9,325

Efficacy: Up to 121 LPW

CRI: Minimum 70 CRI (3000K, 4000K & 5000K); 80 CRI (2700K, 3000K, 4000K & 5000K)

CCT: 2700K, 3000K, 4000K, 5000K

Limited Warranty*: 10 years

* See <http://creelighting.com/warranty> for warranty terms

Accessories

Field-Installed	
Backlight Control Shield RSW-BLSM - Provides 1 mounting height cutoff - 0.5" (13mm) 301 stainless steel construction - Refer to initial delivered lumen tables for lumen output	Cul-De-Sac Shield RSW-CLSM - Provides backlight and sidelight control - 0.5" (13mm) 301 stainless steel construction - Lumen multiplier: 0.77
Bird Guard RSW-BRDGRDM - 5052-H32 aluminum construction	Front Light Shield RSW-FLSM - Provides front light control - 0.5" (13mm) 301 stainless steel construction - Lumen multiplier: 0.87
Shorting Cap XA-XSLSHRT	

Ordering Information

Example: RSWM-A-HT-2ME-9L-27K8-UL-GY-N

RSWM	A	HT		9L		UL		N	
Product	Version	Mounting	Optic	Lumen Package**	CCT/CRI	Voltage	Color Options	Utility Label/Receptacle	Options
RSWM Medium	A	HT Horizontal Tenon	2LG* Type II Long 2ME* Type II Medium 3ME* Type III Medium	9L 9,000 Lumens	27K8 2700K, 80 CRI 30K7 3000K, 70 CRI 30K8 3000K, 80 CRI 40K7 4000K, 70CRI 40K8 4000K, 80 CRI 50K7 5000K, 70CRI 50K8 5000K, 80CRI	UL Universal 120-277V	BK Black BZ Bronze GY Grey	N Utility Label and NEMA® 7-Pin Photocell Receptacle - External wattage label per ANSI C136.15 - 7-pin receptacle per ANSI C136.41 - Factory connected 0-10V dim leads - Requires photocell or shorting cap by others	PP Pallet Packaging - Multiple luminaires (up to 22 maximum per pallet) Q8/Q7/Q6/Q5/Q4/Q3/Q2/Q1 Field Adjustable Lumen Output - Must select Q8, Q7, Q6, Q5, Q4, Q3, Q2, or Q1 - Offers full range lumen adjustability - Includes wattage label for setting selected - Refer to pages 7 & 8 for power and lumen values - Luminaire may also be dimmed through 7-Pin receptacle with use of dimming control by others - Refer to dimming spec sheet for dimming multipliers SS Stainless Steel Bolts X7/X6/X5/X4/X3/X2/X1 Locked Lumen Output - Must select X7, X6, X5, X4, X3, X2, or X1 - Lumen output is permanently locked to the setting selected - Includes wattage label for setting selected - Refer to pages 7 & 8 for power and lumen values - Dimming is only available through 7-Pin receptacle with use of dimming control by others - Refer to dimming spec sheet for dimming multipliers

* Available with Backlight Shield when ordered with field-installed accessory (see table above)

** Lumen Package codes identify approximate light output only. Actual lumen output levels vary depending on CCT and optic selection. Refer to Initial Delivered Lumen tables for specific lumen values



US: creelighting.com (800) 236-6800

Canada: creelighting-canada.com (800) 473-1234

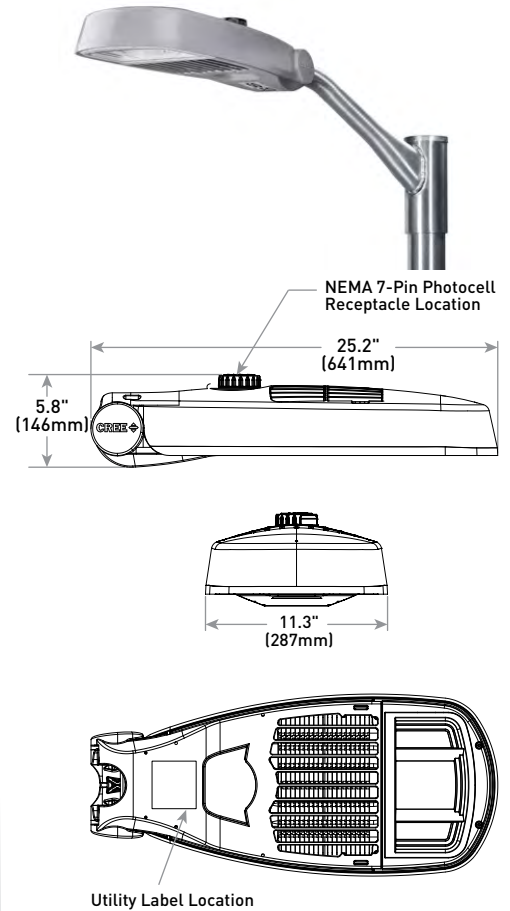

Weight*

15.6 lbs. (7.1 kg)

* RSW-BLSM Accessory: add 0.4 lbs. (0.2kg); RSW-CLSM or RSW-FLSM Accessories: add 0.6 lbs. (0.3kg)



Product Specifications

WAVEMAX® TECHNOLOGY

Featuring up to 90% optical efficiency and precise control, WaveMax® Technology provides unmatched comfort and decreased LED source luminance by smoothly spreading brightness over a broader area. When integrated with luminous surfaces made of a polymer medium engineered with DiamondFacet™ optical elements, extremely high efficacy luminaires are the result – ultimately creating more visually comfortable and appealing environments while exceeding illumination performance.

CONSTRUCTION & MATERIALS

- Housing constructed of high strength, lightweight bulk molding compound for long weathering and durability
- UV stabilized polymeric door with handle pocket for tool-less entry
- Straight in wiring to terminal block for power input [#6-#14 AWG]
- Optic box and driver enclosure inside optic box meet IP66 requirements
- Mounts on 1.25" (32mm) IP, 1.66" (42mm) O.D. or 2" (51mm) IP, 2.375" (60mm) O.D. horizontal tenon (minimum 8" [203mm] in length) and is adjustable +/- 5° in 2.5° increments to allow for fixture leveling (two axis T-level included)
- Luminaire secures with two grade 5 steel mounting bolts w/clear zinc clad finish standard; optional 316 stainless steel mounting bolts available with SS option
- Comes standard with Utility Label per ANSI C136.15 and 7-pin NEMA® Photocell Receptacle per ANSI C136.41
- **Weight:** 15.6 lbs. (7.1kg); add 0.4 lbs. (0.2kg) for RSW-BLSM accessory; add 0.6 lbs. (0.3kg) for RSW-CLSM or RSW-FLSM accessories

ELECTRICAL SYSTEM

- **Input Voltage:** 120-277V, 50/60Hz, Class 1 drivers
- **Power Factor:** > 0.9 at full load
- **Total Harmonic Distortion:** < 20% at full load
- Integral 10kV surge suppression protection standard
- When code dictates fusing, a slow blow fuse or type C/D breaker should be used to address inrush current
- **10V Source Current:** 0.15mA
- **Operating Temperature Range:** -40°C - +50°C (-40°F - + 122°F)

REGULATORY & VOLUNTARY QUALIFICATIONS

- cULus Listed
- Suitable for wet locations
- Certified to ANSI C136.31-2001, 3G bridge and overpass vibration standards
- Meets CALTrans 611 Vibration testing
- ANSI C136.2 10kV surge protection, tested in accordance with IEEE/ANSI C62.41.2
- Meets FCC Part 15, Subpart B, Class A limits for conducted and radiated emissions
- Meets Buy American requirements within ARRA
- RoHS compliance. Consult factory for additional details
- Dark Sky Friendly, IDA Approved when ordered with 27K or 30K CCT. Please refer to <https://www.darksky.org/our-work/lighting/lighting-for-industry/fsa/fsa-products/> for most current information
- DLC and DLC Premium qualified versions available. Please refer to <https://www.designlights.org/search/> for most current information
- **CA RESIDENTS WARNING:** Cancer and Reproductive Harm – www.p65warnings.ca.gov

Product Specifications

SYNAPSE® SIMPLYSNAP INTELLIGENT CONTROL FOR NON-STREET LIGHTING APPLICATIONS ONLY

The RSW Series is compatible with the Synapse® SimplySNAP platform. A highly intuitive connected lighting solution for Site and Area applications only. The system features a reliable and robust self-healing mesh network with a browser-based interface that runs on smartphones, tablets, and PCs. Using a Twist-Lock Lighting Controller and Site Controller, SimplySnap provides: energy productivity, code compliance and a better light experience for non-street lighting installations. SimplySNAP is optimized to create and manage networks for campus wide Area and Site applications which differs from networking requirements for street lighting applications.

Synapse Wireless Control Accessories (for Non-Street Lighting Applications only)	
Twist-Lock Lighting Controller TL7-B2 - Suitable for 120-277V (UL) voltage only - Requires NEMA/ANSI C136.41 7-Pin Dimming Receptacle - Not for use with Q options - Provides On/Off switching, dimming, power metering, digital sensor input, and status monitoring of luminaires - Refer to TL7-B2 spec sheet for details SimplySNAP Central Base Station CBSW-450-002 - Includes On-Site Controller (SS450-002) and 5-button switch - Indoor and Outdoor rated - Refer to CBSW-450-002 spec sheet for details Synapse Wireless Sensor WSN-DPM - Motion and light sensor - Control multiple zones - Refer to WSN-DPM spec sheet for details	SimplySNAP On-Site Controller SS450-002 - Verizon® LTE-enabled - Designed for indoor applications - Refer to SS450-002 spec sheet for details Building Management System (BMS) Gateway BMS-GW-002 - Required for BACnet integration - Refer to BMS-GW-002 spec sheet for details Outdoor Antennas (Optional, for increased range, 8dB gain) KIT-ANT420SM - Kit includes antenna, 20' cable and bracket KIT-ANT360 - Kit includes antenna, 30' cable and bracket KIT-ANT600 - Kit includes antenna, 50' cable and bracket - Refer to Outdoor antenna spec sheet for details

Electrical Data*								
Lumen Package	CCT/CRI	System Watts 120-277V	Utility Label Wattage	Efficacy	Total Current (A)			
					120V	208V	240V	277V
9L	27K8	83	80	98	0.74	0.42	0.36	0.32
	30K7	83	80	112	0.74	0.42	0.36	0.32
	30K8	83	80	105	0.74	0.42	0.36	0.32
	40K7	78	80	120	0.70	0.40	0.34	0.30
	40K8	83	80	111	0.74	0.42	0.36	0.32
	50K7	77	80	121	0.69	0.39	0.34	0.29
	50K8	80	80	117	0.72	0.41	0.35	0.31

* Electrical data at 25°C (77°F). Actual wattage may differ by +/- 10% when operating between 120-277V +/- 10%

RSW Series (RSWM) Ambient Adjusted Lumen Maintenance ¹					
Ambient	Initial LMF	25K hr Reported ² LMF	50K hr Reported ² LMF	75K hr Estimated ³ LMF	100K hr Estimated ³ LMF
5°C (41°F)	1.04	1.04	1.04	1.04	1.04
10°C (50°F)	1.03	1.03	1.03	1.03	1.03
15°C (59°F)	1.02	1.02	1.02	1.02	1.02
20°C (68°F)	1.01	1.01	1.01	1.01	1.01
25°C (77°F)	1.00	1.00	1.00	1.00	1.00

¹ Lumen maintenance values at 25°C (77°F) are calculated per IES TM-21 based on IES LM-80 report data for the LED package and in-situ luminaire testing. Luminaire ambient temperature factors (LATF) have been applied to all lumen maintenance factors. Please refer to the [Temperature Zone Reference Document](#) for outdoor average nighttime ambient conditions.

² In accordance with IES TM-21, Reported values represent interpolated values based on time durations that are up to 6x the tested duration in the IES LM-80 report for the LED.

³ Estimated values are calculated and represent time durations that exceed the 6x test duration of the LED.

Photometry

All published luminaire photometric testing performed to IES LM-79-08 standards. To obtain an IES file specific to your project consult: <https://creelighting.com/products/outdoor/street-and-roadway/rsw-series>

2LG

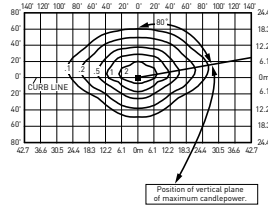
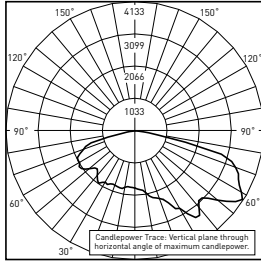

UL Verification Services Test Report #:
12311460.01
RSWM-A-**-2LG-9L-30K7-UL-**-N
Initial Delivered Lumens: 9,178

RSWM-A-**-2LG-9L-30K7-UL-**-N
Mounting Height: 25' [7.6m] A.F.G.
Initial Delivered Lumens: 9,325
Initial FC at grade

Type II Long Distribution									
Lumen Package	CRI	2700K		3000K		4000K		5000K	
		Initial Delivered Lumens*	BUG Ratings** Per TM-15-11	Initial Delivered Lumens*	BUG Ratings** Per TM-15-11	Initial Delivered Lumens*	BUG Ratings** Per TM-15-11	Initial Delivered Lumens*	BUG Ratings** Per TM-15-11
9L	70	N/A	N/A	9,325	B2 U0 G2	9,325	B2 U0 G2	9,325	B2 U0 G2
	80	8,175	B2 U0 G2	8,700	B2 U0 G2	9,200	B2 U0 G2	9,325	B2 U0 G2

* Initial delivered lumens at 25°C (77°F). Actual production yield may vary between -10 and +10% of initial delivered lumens
 ** For more information on the IES BUG (Backlight-Uplight-Glare) Rating visit: <https://www.ies.org/wp-content/uploads/2017/03/TM-15-11BUGRatingsAddendum.pdf>. Valid with no tilt

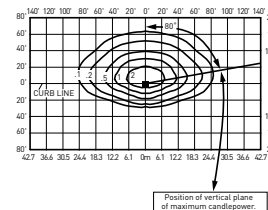
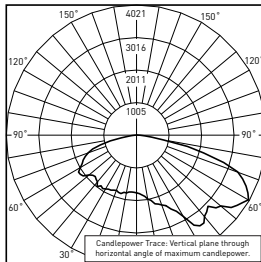

UL Verification Services Test Report #:
11705478-02
RSWM-A-**-2LG-9L-30K7-UL-**-N
w/RSW-BLSM
Initial Delivered Lumens: 8,466

RSWM-A-**-2LG-9L-30K7-UL-**-N
w/RSW-BLSM
Mounting Height: 25' [7.6m] A.F.G.
Initial Delivered Lumens: 8,550
Initial FC at grade

Type II Long w/BLS Distribution									
Lumen Package	CRI	2700K		3000K		4000K		5000K	
		Initial Delivered Lumens*	BUG Ratings** Per TM-15-11	Initial Delivered Lumens*	BUG Ratings** Per TM-15-11	Initial Delivered Lumens*	BUG Ratings** Per TM-15-11	Initial Delivered Lumens*	BUG Ratings** Per TM-15-11
9L	70	N/A	N/A	8,550	B2 U0 G2	8,550	B2 U0 G2	8,550	B2 U0 G2
	80	7,500	B2 U0 G2	7,975	B2 U0 G2	8,450	B2 U0 G2	8,550	B2 U0 G2

* Initial delivered lumens at 25°C (77°F). Actual production yield may vary between -10 and +10% of initial delivered lumens
 ** For more information on the IES BUG (Backlight-Uplight-Glare) Rating visit: <https://www.ies.org/wp-content/uploads/2017/03/TM-15-11BUGRatingsAddendum.pdf>. Valid with no tilt

Photometry

All published luminaire photometric testing performed to IES LM-79-08 standards. To obtain an IES file specific to your project consult: <https://creelighting.com/products/outdoor/street-and-roadway/rsw-series>

2ME

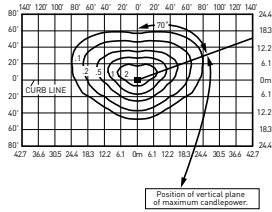
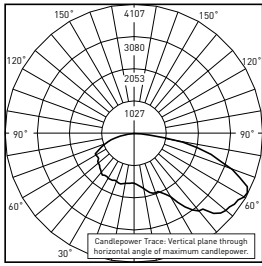

UL Verification Services Test Report #:
12311460.05
RSWM-A-**-2ME-9L-30K7-UL-**-N
Initial Delivered Lumens: 9,487

RSWM-A-**-2ME-9L-30K7-UL-**-N
Mounting Height: 25' (7.6m) A.F.G.
Initial Delivered Lumens: 9,325
Initial FC at grade

Type II Medium Distribution									
Lumen Package	CRI	2700K		3000K		4000K		5000K	
		Initial Delivered Lumens*	BUG Ratings** Per TM-15-11	Initial Delivered Lumens*	BUG Ratings** Per TM-15-11	Initial Delivered Lumens*	BUG Ratings** Per TM-15-11	Initial Delivered Lumens*	BUG Ratings** Per TM-15-11
9L	70	N/A	N/A	9,325	B2 U0 G3	9,325	B2 U0 G3	9,325	B2 U0 G3
	80	8,175	B2 U0 G2	8,700	B2 U0 G2	9,200	B2 U0 G3	9,325	B2 U0 G3

* Initial delivered lumens at 25°C (77°F). Actual production yield may vary between -10 and +10% of initial delivered lumens
** For more information on the IES BUG (Backlight-Uplight-Glare) Rating visit: <https://www.ies.org/wp-content/uploads/2017/03/TM-15-11BUGRatingsAddendum.pdf>. Valid with no tilt

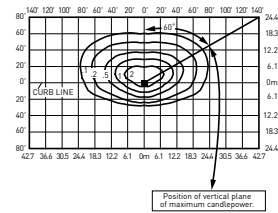
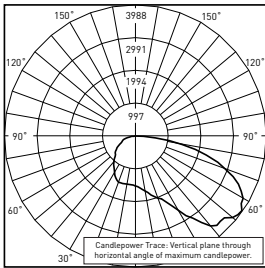

UL Verification Services Test Report #:
11705478.01
RSWM-A-**-2ME-9L-30K7-UL-**-N
w/RSW-BLSM
Initial Delivered Lumens: 8,383

RSWM-A-**-2ME-9L-30K7-UL-**-N
w/RSW-BLSM
Mounting Height: 25' (7.6m) A.F.G.
Initial Delivered Lumens: 8,550
Initial FC at grade

Type II Medium w/BLS Distribution									
Lumen Package	CRI	2700K		3000K		4000K		5000K	
		Initial Delivered Lumens*	BUG Ratings** Per TM-15-11	Initial Delivered Lumens*	BUG Ratings** Per TM-15-11	Initial Delivered Lumens*	BUG Ratings** Per TM-15-11	Initial Delivered Lumens*	BUG Ratings** Per TM-15-11
9L	70	N/A	N/A	8,550	B2 U0 G3	8,550	B2 U0 G3	8,550	B2 U0 G3
	80	7,500	B1 U0 G2	7,975	B2 U0 G2	8,450	B2 U0 G3	8,550	B2 U0 G3

* Initial delivered lumens at 25°C (77°F). Actual production yield may vary between -10 and +10% of initial delivered lumens
** For more information on the IES BUG (Backlight-Uplight-Glare) Rating visit: <https://www.ies.org/wp-content/uploads/2017/03/TM-15-11BUGRatingsAddendum.pdf>. Valid with no tilt

Photometry

All published luminaire photometric testing performed to IES LM-79-08 standards. To obtain an IES file specific to your project consult: <https://creelighting.com/products/outdoor/street-and-roadway/rsw-series>

3ME

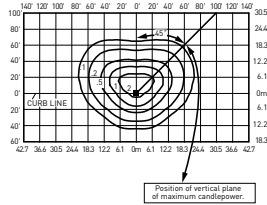
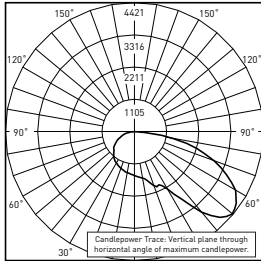

UL Verification Services Test Report #:
12311460.02
RSWM-A**-3ME-9L-30K7-UL**-N
Initial Delivered Lumens: 9,302

RSWM-A**-3ME-9L-30K7-UL**-N
Mounting Height: 25' (7.6m) A.F.G.
Initial Delivered Lumens: 9,325
Initial FC at grade

Type III Medium Distribution									
Lumen Package	CRI	2700K		3000K		4000K		5000K	
		Initial Delivered Lumens*	BUG Ratings** Per TM-15-11	Initial Delivered Lumens*	BUG Ratings** Per TM-15-11	Initial Delivered Lumens*	BUG Ratings** Per TM-15-11	Initial Delivered Lumens*	BUG Ratings** Per TM-15-11
9L	70	N/A	N/A	9,325	B2 U0 G2	9,325	B2 U0 G2	9,325	B2 U0 G2
	80	8,175	B2 U0 G2	8,700	B2 U0 G2	9,200	B2 U0 G2	9,325	B2 U0 G2

* Initial delivered lumens at 25°C (77°F). Actual production yield may vary between -10 and +10% of initial delivered lumens

** For more information on the IES BUG (Backlight-Uplight-Glare) Rating visit: <https://www.ies.org/wp-content/uploads/2017/03/TM-15-11BUGRatingsAddendum.pdf>. Valid with no tilt

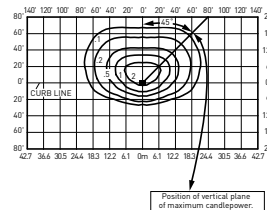
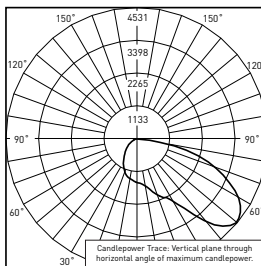

UL Verification Services Test Report #
11705478.03
RSWM-A**-3ME-9L-30K7-UL**-N
w/RSW-BLSM
Initial Delivered Lumens: 8,532





RSWM-A**-3ME-9L-30K7-UL**-N
w/RSW-BLSM
Mounting Height: 25' (7.6m) A.F.G.
Initial Delivered Lumens: 8,550
Initial FC at grade

Type III Medium w/BLS Distribution									
Lumen Package	CRI	2700K		3000K		4000K		5000K	
		Initial Delivered Lumens*	BUG Ratings** Per TM-15-11	Initial Delivered Lumens*	BUG Ratings** Per TM-15-11	Initial Delivered Lumens*	BUG Ratings** Per TM-15-11	Initial Delivered Lumens*	BUG Ratings** Per TM-15-11
9L	70	N/A	N/A	8,550	B2 U1 G2	8,550	B2 U1 G2	8,550	B2 U1 G2
	80	7,500	B1 U1 G2	7,975	B1 U1 G2	8,450	B2 U1 G2	8,550	B2 U1 G2

* Initial delivered lumens at 25°C (77°F). Actual production yield may vary between -10 and +10% of initial delivered lumens

** For more information on the IES BUG (Backlight-Uplight-Glare) Rating visit: <https://www.ies.org/wp-content/uploads/2017/03/TM-15-11BUGRatingsAddendum.pdf>. Valid with no tilt

Luminaire EPA

Horizontal Tenon Mount – Weight: 15.6 lbs. (7.1kg); RSW-BLSM Accessory: add 0.4 lbs. (0.2kg); RSW-CLSM or RSW-FLSM Accessories: add 0.6 lbs. (0.3kg)					
Luminaire	Single	2 @ 90°	2 @ 180°	3 @ 90°	4 @ 90°
Tenon Configuration If used with Cree Lighting tenons, please add tenon EPA with luminaire EPA					
					
	PD-1H4; PT-1H	PD-2H4(90); PT-2H(90)	PD-2H4(180); PT-2H(180)	PD-3H4(90); PT-3H(90)	PD-4H4(90); PT-4H(90)
Standard Luminaire	0.86	1.24	1.71	2.10	2.49
Luminaire w/RSW-BLSM, RSW-CLSM or RSW-FLSM Accessory	0.86	1.59	1.71	2.45	3.19

Tenon EPA

Part Number	EPA
PD Series Tenons	0.09
PT Series Tenons	0.10
WM-2L	0.13
XA-TMDA8	0.19

Tenons and Brackets* (must specify color)	
<p>Square Internal Mount Horizontal Tenons (Aluminum) - Mounts to 4" (102mm) square aluminum or steel poles PD-1H4 – Single PD-3H4(90) – 90° Triple PD-2H4(90) – 90° Twin PD-4H4(90) – 90° Quad PD-2H4(180) – 180° Twin</p> <p>Wall Mount Brackets - Mounts to wall or roof WM-2L – Extended Horizontal</p>	<p>Round External Mount Horizontal Tenons (Aluminum) - Mounts to 2.375"-3" (60-76mm) O.D. round aluminum or steel poles or tenons PT-1H – Single PT-3H(90) – 90° Triple PT-2H(90) – 90° Twin PT-4H(90) – 90° Quad PT-2H(180) – 180° Twin</p> <p>Direct Arm Pole Adaptor Bracket - Mounts to 3-6" (76-152mm) round or square aluminum or steel poles XA-TMDA8</p>

* Refer to the [Bracket and Tenons spec sheet](#) for more details

Field Adjustable Output (Q8/Q7/Q6/Q5/Q4/Q3/Q2/Q1) Option Description:

The Field Adjustable Output option enables the street and area luminaire within the RSW Series on this page to be tuned to the exact needs of a particular application through multiple levels of adjustment. When ordered with the Q option, the luminaire will be shipped from the factory at the selected lumen output, will be fully adjustable between the outputs, and will include a wattage label that indicates the wattage of the luminaire at the selected lumen output (Rounded to nearest 10 watts per ANSI C136.15-2015.). Additional dimming functionality is available when a dimming control (by others) is used in the 7-Pin receptacle.

Locked Lumen Output (X7/X6/X5/X4/X3/X2/X1) Option Description:

The Locked Lumen Output option on this page permanently locks the lumen output on the RSW Series street and area luminaire to the setting selected. When ordered with the X option, the luminaire will be shipped from the factory at the lumen output setting selected, and will include a wattage label that indicates the wattage of the setting selected. When this option is selected, the luminaire output is not able to be adjusted in the field except if a dimming control (by others) is used in the 7-Pin receptacle.

Q & X Option Power & Lumen Data – 9L

Q Option Setting	X Option Setting	CCT/CRI	System Watts [†]		Lumen Values [†]		Optics Qualified on DLC QPL	
			120-277V	Label Wattage	2LG, 2ME & 3ME	w/BLS	Standard	Premium
Q8 (Full Power)	N/A (Full Power)	27K8	83	80	8,175	7,500	2LG, 2ME, 3ME	
		30K7	83	80	9,325	8,550		2LG, 2ME, 3ME
		30K8	83	80	8,700	7,975	2LG, 2ME, 3ME	
		40K7	78	80	9,325	8,550		2LG, 2ME, 3ME
		40K8	83	80	9,200	8,450	2LG, 2ME, 3ME	
		50K7	77	80	9,325	8,550		2LG, 2ME, 3ME
		50K8	80	80	9,325	8,550		2LG, 2ME, 3ME
Q7	X7	27K8	81	80	7,975	7,325	2LG, 2ME, 3ME	
		30K7	81	80	9,100	8,350		2LG, 2ME, 3ME
		30K8	81	80	8,500	7,800	2LG, 2ME, 3ME	
		40K7	76	80	9,100	8,350		2LG, 2ME, 3ME
		40K8	81	80	8,975	8,250	2LG, 2ME, 3ME	
		50K7	75	80	9,100	8,350		2LG, 2ME, 3ME
		50K8	78	80	9,100	8,350		2LG, 2ME, 3ME
Q6	X6	27K8	75	80	7,850	7,200	2LG, 2ME, 3ME	
		30K7	75	80	8,975	8,250		2LG, 2ME, 3ME
		30K8	75	80	8,375	7,675	2LG, 2ME, 3ME	
		40K7	71	70	8,975	8,250		2LG, 2ME, 3ME
		40K8	75	80	8,850	8,125		2LG, 2ME, 3ME
		50K7	70	70	8,975	8,250		2LG, 2ME, 3ME
		50K8	73	70	8,975	8,250		2LG, 2ME, 3ME
Q5	X5	27K8	69	70	7,300	6,700	2LG, 2ME, 3ME	
		30K7	69	70	8,325	7,650		2LG, 2ME, 3ME
		30K8	69	70	7,775	7,125	2LG, 2ME, 3ME	
		40K7	65	70	8,325	7,650		2LG, 2ME, 3ME
		40K8	69	70	8,225	7,550		2LG, 2ME, 3ME
		50K7	64	60	8,325	7,650		2LG, 2ME, 3ME
		50K8	67	70	8,325	7,650		2LG, 2ME, 3ME

[†] Electrical and lumen data at 25°C (77°F). Actual wattage and lumen output may differ by +/-10% when operating between 120-277V +/-10%

Field Adjustable Output (Q8/Q7/Q6/Q5/Q4/Q3/Q2/Q1) Option Description:

The Field Adjustable Output option enables the street and area luminaire within the RSW Series on this page to be tuned to the exact needs of a particular application through multiple levels of adjustment. When ordered with the Q option, the luminaire will be shipped from the factory at the selected lumen output, will be fully adjustable between the outputs, and will include a wattage label that indicates the wattage of the luminaire at the selected lumen output (Rounded to nearest 10 watts per ANSI C136.15-2015.). Additional dimming functionality is available when a dimming control (by others) is used in the 7-Pin receptacle.

Locked Lumen Output (X7/X6/X5/X4/X3/X2/X1) Option Description:

The Locked Lumen Output option on this page permanently locks the lumen output on the RSW Series street and area luminaire to the setting selected. When ordered with the X option, the luminaire will be shipped from the factory at the lumen output setting selected, and will include a wattage label that indicates the wattage of the setting selected. When this option is selected, the luminaire output is not able to be adjusted in the field except if a dimming control (by others) is used in the 7-Pin receptacle.

Q & X Option Power & Lumen Data – 9L

Q Option Setting	X Option Setting	CCT/CRI	System Watts†		Lumen Values†		Optics Qualified on DLC QPL	
			120-277V	Label Wattage	2LG, 2ME & 3ME	w/BLS	Standard	Premium
Q4	X4	27K8	65	70	6,800	6,250	2LG, 2ME, 3ME	
		30K7	65	70	7,750	7,125		2LG, 2ME, 3ME
		30K8	65	70	7,225	6,625	2LG, 2ME, 3ME	
		40K7	62	60	7,750	7,125		2LG, 2ME, 3ME
		40K8	65	70	7,650	7,025		2LG, 2ME, 3ME
		50K7	61	60	7,750	7,125		2LG, 2ME, 3ME
		50K8	63	60	7,750	7,125		2LG, 2ME, 3ME
Q3	X3	27K8	61	60	6,400	5,875	2LG, 2ME, 3ME	
		30K7	61	60	7,300	6,700		2LG, 2ME, 3ME
		30K8	61	60	6,825	6,275		2LG, 2ME, 3ME
		40K7	59	60	7,300	6,700		2LG, 2ME, 3ME
		40K8	61	60	7,200	6,600		2LG, 2ME, 3ME
		50K7	58	60	7,300	6,700		2LG, 2ME, 3ME
		50K8	60	60	7,300	6,700		2LG, 2ME, 3ME
Q2	X2	27K8	60	60	6,125	5,625	2LG, 2ME, 3ME	
		30K7	60	60	7,000	6,425		2LG, 2ME, 3ME
		30K8	60	60	6,525	6,000		2LG, 2ME, 3ME
		40K7	56	60	7,000	6,425		2LG, 2ME, 3ME
		40K8	60	60	6,900	6,325		2LG, 2ME, 3ME
		50K7	56	60	7,000	6,425		2LG, 2ME, 3ME
		50K8	58	60	7,000	6,425		2LG, 2ME, 3ME
Q1	X1	27K8	50	50	5,700	5,225	2LG, 2ME, 3ME	
		30K7	50	50	6,500	5,975		2LG, 2ME, 3ME
		30K8	50	50	6,050	5,550		2LG, 2ME, 3ME
		40K7	48	50	6,500	5,975		2LG, 2ME, 3ME
		40K8	50	50	6,400	5,875		2LG, 2ME, 3ME
		50K7	47	50	6,500	5,975		2LG, 2ME, 3ME
		50K8	49	50	6,500	5,975		2LG, 2ME, 3ME

† Electrical and lumen data at 25°C (77°F). Actual wattage and lumen output may differ by +/-10% when operating between 120-277V +/-10%