

Cree Edge™ Series

LED Pathway Luminaire

Product Description

Durable die-cast aluminum luminaire housing mounts directly to 4" (102mm) diameter pole (included) without visible mounting hardware for clean appearance. Pole mounts to rugged die cast aluminum internal flange secured by three 3/8" - 16x6" anchor bolts with 1-1/4" hook (provided). **Note:** T45 Torx 3/8" socket required for head installation. Top mounted LEDs for superior optical performance and light control.

Applications: Landscape, walk-ways and general site lighting

Performance Summary

Patented NanoOptic® Product Technology

Made in the U.S.A. of U.S. and imported parts

CRI: Minimum 70 CRI

CCT: 4000K (+/- 300K), 5700K (+/- 500K) standard

Limited Warranty*: 10 years on luminaire/10 years on Colorfast DeltaGuard® finish

* See <http://lighting.cree.com/warranty> for warranty terms

Accessories

Field-Installed
Upgrade Kit - Used for replacement of existing bollards with a bolt hole circle of 5.75" (146mm) XA-XBP8RSV XA-XBP8RWH XA-XBP8RBK XA-XBP8RBZ

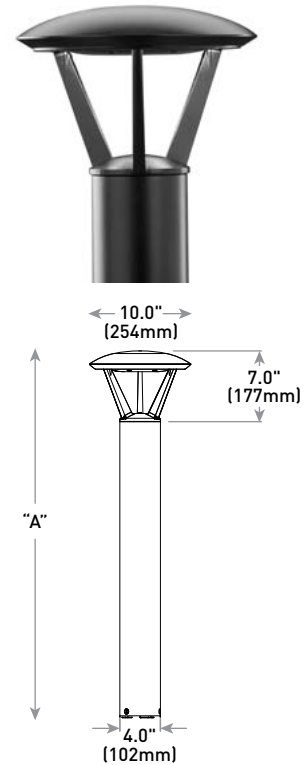

Model	Dim. "A"	Weight*
Landscape (P0)	13" (330mm)	12.7 lbs. (5.8kg)
Landscape (P1)	18" (457mm)	13.3 lbs. (6.0kg)
Pathway (P3)	36" (914mm)	17.9 lbs. (8.1kg)
Pathway (P4)	42" (1068mm)	18.6 lbs. (8.4kg)
Pedestrian (P8)	96" (2438mm)	28.4 lbs (12.9kg)

* Add 4.5 lbs. (2.0kg) for 347-480V

Ordering Information

Example: PWY-EDG-2M-P0-02-E-UL-SV-350

PWY-EDG	Optic	Mounting	LED Count (x9)	Series	Voltage	Color Options	Drive Current	Options
PWY-EDG	2M Type II Medium 3M Type III Medium 5M Type V Medium 5S Type V Short	P0 13" (330mm) landscape P1 18" (457mm) landscape P3 36" (914mm) pathway P4 42" (1067mm) pathway P8 96" (2438mm) pedestrian	02	E	UL Universal 120-277V UH* Universal 347-480V - Available with P3, P4, and P8 mounts only 12 120V 27 277V	BK Black BZ Bronze SV Silver WH White	350 350mA 525 525mA - Available with P1, P3, P4, and P8 mounts only	F Fuse - When code dictates fusing, use time delay fuse - Refer to ML spec sheet for availability with ML options HL Hi/Low (Dual Circuit Input) - Available with UL voltage and 525mA driver current only - Refer to HL spec sheet for details - Sensor not included TL Two-Level (175/525 w/integrated sensor control) - Available with 12 or 27 voltages only - Refer to TL spec sheet for details TL2 Two-Level (0/350 w/integrated sensor control) - Available with 12 or 27 voltages only - Refer to TL spec sheet for details TL3 Two-Level (0/525 w/integrated sensor control) - Available with 12 or 27 voltages only - Refer to TL spec sheet for details WB Welded Base Plate - Standard on P8 mount option, available with P3 and P4 mount - Includes welded base cover 40K 4000K Color Temperature - Minimum 70 CRI - Color temperature per luminaire

* 347-480V utilizes magnetic step-down transformer. For input power for 347-480V, refer to the Electrical Data table



US: lighting.cree.com

T (800) 236-6800 F (262) 504-5415

Rev. Date: V5 10/16/2018

Canada: www.cree.com/canada



T (800) 473-1234 F (800) 890-7507

Product Specifications

CONSTRUCTION & MATERIALS

- Durable die-cast aluminum luminaire housing mounts directly to 4" (102mm) diameter pole (included) without visible mounting hardware for clean appearance
- Pole mounts to rugged die cast aluminum internal flange secured by three 3/8"-16x6" anchor bolts with 1-1/4" hook (provided).
Note: T45 Torx 3/8" socket required for head installation
- Top mounted LEDs for superior optical performance and light control
- Exclusive Colorfast DeltaGuard® finish features an E-Coat epoxy primer with an ultradurable powder topcoat, providing excellent resistance to corrosion, ultraviolet degradation and abrasion. Black, bronze, silver and white are available
- **Weight:** See Dimension and Weight Chart on pages 1 and 4

ELECTRICAL SYSTEM

- **Input Voltage:** 120-277V or 347-480V, 50/60Hz, Class 1 drivers
- **Power Factor:** > 0.9 at full load at 120V
- **Total Harmonic Distortion:** < 20% at full load at 120V
- Integral 10kV surge suppression protection standard
- When code dictates fusing, a slow blow fuse or type C/D breaker should be used to address inrush current

REGULATORY & VOLUNTARY QUALIFICATIONS

- cULus Listed
- Suitable for wet locations
- 10kV surge suppression protection tested in accordance with IEEE/ANSI C62.41.2
- Luminaire and finish endurance tested to withstand 5,000 hours of elevated ambient salt fog conditions as defined in ASTM Standard B 117
- Meets Buy American requirements within ARRA
- RoHS compliant. Consult factory for additional details
- **CA RESIDENTS WARNING:** Cancer and Reproductive Harm – www.p65warnings.ca.gov

Electrical Data* (A)								
LED Count (x9)	System Watts 120-277V	System Watts 347-480V	Total Current					
			120V	208V	240V	277V	347V	480V
350mA								
02	22	28	0.18	0.12	0.10	0.10	0.09	0.13
525mA								
02	34	40	0.29	0.19	0.17	0.15	0.12	0.13

* Electrical data at 25°C (77°F). Actual wattage may differ by +/- 10% when operating between 120-480V +/- 10%

Recommended Cree Edge™ Series Lumen Maintenance Factors (LMF) ¹					
Ambient	Initial LMF	25K hr Projected ² LMF	50K hr Projected ² LMF	75K hr Calculated ³ LMF	100K hr Calculated ³ LMF
5°C (41°F)	1.04	0.99	0.97	0.95	0.93
10°C (50°F)	1.03	0.98	0.96	0.94	0.92
15°C (59°F)	1.02	0.97	0.95	0.93	0.91
20°C (68°F)	1.01	0.96	0.94	0.92	0.90
25°C (77°F)	1.00	0.95	0.93	0.91	0.89

¹ Lumen maintenance values at 25°C are calculated per TM-21 based on LM-80 data and in-situ luminaire testing

² In accordance with IESNA TM-21-11, Projected Values represent interpolated value based on time durations that are within six times (6X) the IESNA LM-80-08 total test duration (in hours) for the device under testing ((DUT) i.e. the packaged LED chip)

³ In accordance with IESNA TM-21-11, Calculated Values represent time durations that exceed six times (6X) the IESNA LM-80-08 total test duration (in hours) for the device under testing ((DUT) i.e. the packaged LED chip)

Photometry

All published luminaire photometric testing performed to IESNA LM-79-08 standards by a NVLAP accredited laboratory. To obtain an IES file specific to your project consult: <http://lighting.cree.com/products/outdoor/bollards-and-pathway/cree-edge-pathway>

2M

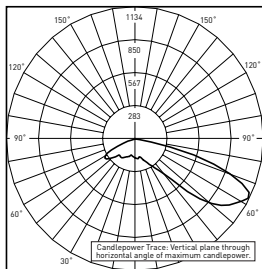

RESTL Test Report #: PL5758-001
 PWY-EDG-2M-**-02-E-UL-350-40K
 Initial Delivered Lumens: 1,549

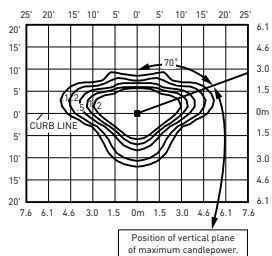

PWY-EDG-2M-**-02-E-UL-350-40K
 Mounting Height: 3' [0.9m] A.F.G.
 Initial Delivered Lumens: 1,565
 Initial FC at grade

Type II Medium Distribution				
LED Count (x9)	4000K		5700K	
	Initial Delivered Lumens*	BUG Ratings** Per TM-15-11	Initial Delivered Lumens*	BUG Ratings** Per TM-15-11
350mA				
02	1,565	B1 U0 G1	1,625	B1 U0 G1
525mA				
02	2,191	B1 U0 G1	2,276	B1 U0 G1

* Initial delivered lumens at 25°C (77°F). Actual production yield may vary between -10 and +10% of initial delivered lumens
 ** For more information on the IES BUG (Backlight-Uplight-Glare) Rating visit: www.ies.org/PDF/Erratas/TM-15-11BugRatingsAddendum.pdf

3M

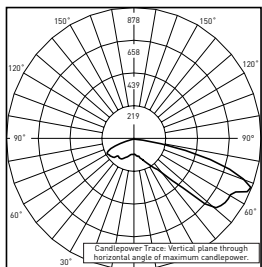

RESTL Test Report #: PL5698-001
 PWY-EDG-3M-**-02-E-UL-350-40K
 Initial Delivered Lumens: 1,470

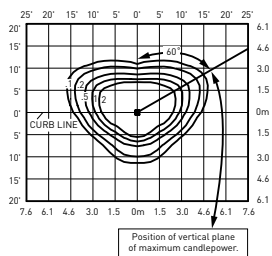

PWY-EDG-3M-**-02-E-UL-350-40K
 Mounting Height: 3' [0.9m] A.F.G.
 Initial Delivered Lumens: 1,389
 Initial FC at grade

Type III Medium Distribution				
LED Count (x9)	4000K		5700K	
	Initial Delivered Lumens*	BUG Ratings** Per TM-15-11	Initial Delivered Lumens*	BUG Ratings** Per TM-15-11
350mA				
02	1,389	B1 U0 G1	1,442	B1 U0 G1
525mA				
02	1,944	B1 U0 G1	2,019	B1 U0 G1

* Initial delivered lumens at 25°C (77°F). Actual production yield may vary between -10 and +10% of initial delivered lumens
 ** For more information on the IES BUG (Backlight-Uplight-Glare) Rating visit: www.ies.org/PDF/Erratas/TM-15-11BugRatingsAddendum.pdf

5M

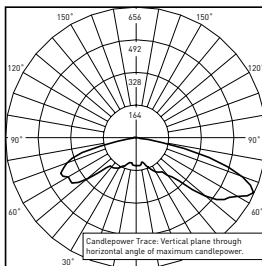

RESTL Test Report #: PL5798-001
 PWY-EDG-5M-**-02-E-UL-350-40K
 Initial Delivered Lumens: 1,780

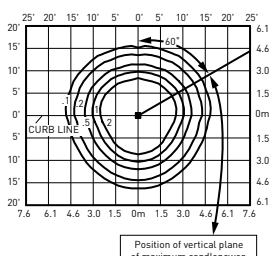

PWY-EDG-5M-**-02-E-UL-350-40K
 Mounting Height: 3' [0.9m] A.F.G.
 Initial Delivered Lumens: 1,666
 Initial FC at grade

Type V Medium Distribution				
LED Count (x9)	4000K		5700K	
	Initial Delivered Lumens*	BUG Ratings** Per TM-15-11	Initial Delivered Lumens*	BUG Ratings** Per TM-15-11
350mA				
02	1,666	B1 U2 G1	1,730	B1 U2 G1
525mA				
02	2,333	B2 U2 G2	2,422	B2 U2 G2

* Initial delivered lumens at 25°C (77°F). Actual production yield may vary between -10 and +10% of initial delivered lumens
 ** For more information on the IES BUG (Backlight-Uplight-Glare) Rating visit: www.ies.org/PDF/Erratas/TM-15-11BugRatingsAddendum.pdf



Photometry

All published luminaire photometric testing performed to IESNA LM-79-08 standards by a NVLAP accredited laboratory. To obtain an IES file specific to your project consult: <http://lighting.cree.com/products/outdoor/bollards-and-pathway/cree-edge-pathway>

55

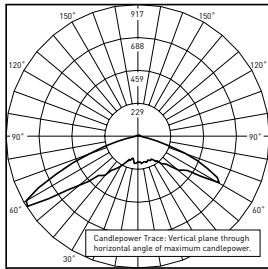

RESTL Test Report #: PL5759-001
 PWY-EDG-5S-**-02-E-UL-350-40K
 Initial Delivered Lumens: 1,897

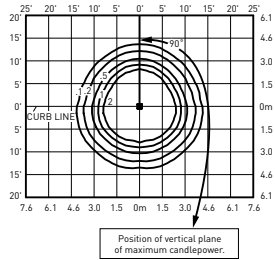

PWY-EDG-5S-**-02-E-UL-350-40K
 Mounting Height: 3' [0.9m] A.F.G.
 Initial Delivered Lumens: 1,868
 Initial FC at grade

Type V Short Distribution				
LED Count (x9)	4000K		5700K	
	Initial Delivered Lumens*	BUG Ratings** Per TM-15-11	Initial Delivered Lumens*	BUG Ratings** Per TM-15-11
350mA				
02	1,868	B1 U2 G1	1,940	B1 U2 G1
525mA				
02	2,615	B1 U2 G1	2,716	B1 U2 G1

* Initial delivered lumens at 25°C (77°F). Actual production yield may vary between -10 and +10% of initial delivered lumens
 ** For more information on the IES BUG (Backlight-Uplight-Glare) Rating visit: www.ies.org/PDF/Erratas/TM-15-11BugRatingsAddendum.pdf

with Welded Base

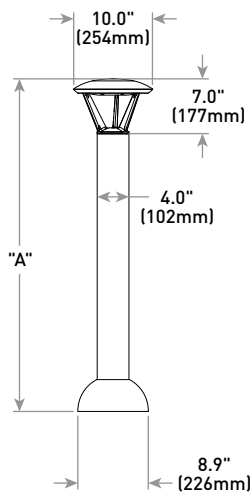

Model	Dim. "A"	Weight*
Pathway (P3)	36" [914mm]	17.9 lbs. [8.1kg]
Pathway (P4)	42" [1068mm]	18.6 lbs. [8.4kg]
Pedestrian (P8)	96" [2438mm]	28.4 lbs [12.9kg]

* Add 4.5 lbs. [2.0kg] for 347-480V