

# RUL Series

RUL™ LED Rural Utility Luminaire

Rev. Date: V11 04/08/2020

## Product Description

The RUL™ LED Rural Utility luminaire delivers ultra-efficient LED lighting with a low total cost of ownership and a quick return on investment for end users requiring a 70-100W HPS or 100-175W Mercury Vapor replacement solution. By providing industry-leading efficacy of up to 114 lumens per watt and an industry-leading 10-year limited warranty, Cree Lighting is changing the assumptions associated with purchasing and maintaining utility and residential security lighting. While its lightweight design, tool-less entry, and easy installation make the RUL™ LED Rural Utility Luminaire an ideal solution for any contractor. Kitted options available.

**Applications:** Rural, residential, street lighting, agricultural, and general security lighting

## Performance Summary

**Efficacy:** Up to 114 LPW

**CRI:** Minimum 70 CRI

**CCT:** 3000K (+/- 300K), 4000K (+/- 300K)

**Limited Warranty\*:** 10 years on luminaire and photocell/7 years on arm mount/  
5 years on reflector/refractor/1 year on shorting cap

\* See <http://creelighting.com/warranty> for warranty terms

## Accessories

Field-Installed	
<b>Arm Mount</b> RUL-ARM24 - 24.0" (610mm) curved raw aluminum arm mount - Includes zinc-plated steel hardware - Mounts to wood poles - Weight: 1.82 lbs. (0.8kg)	<b>Long-Life Photocell</b> RUL-PEC - Must be ordered with RUL luminaire - Weight: 0.28 lbs. (0.1kg)
<b>Shorting Cap</b> XA-XSLSHRT	<b>NEMA® Style Reflector/Refractor</b> RUL-REF - Must be ordered with RUL luminaire - Weight: 2.20 lbs. (1.0kg)



RUL Luminaire w/ES-K1 Option shown (photocell, 10kV surge suppression protection, 7' cord, and arm not included with standard luminaire)

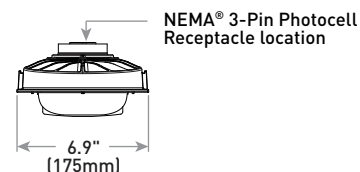
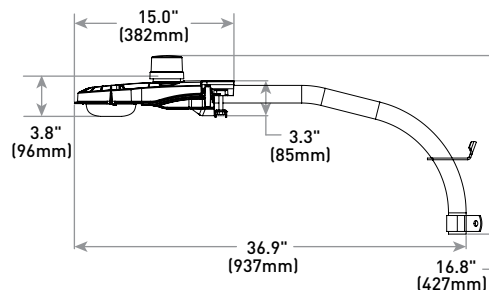

Weight*
3.75 lbs (1.7kg)

\* RUL-ARM24/ES-K1 Option: add 1.82 lbs. (0.8kg)

Luminaire w/ES-K2 option shown on page 4

## Ordering Information

Example: RULHT2MEC30K-12UFN

RUL	HT		C		12	UF	N	
Product	Mounting	Optic	Input Power Designator	CCT	Voltage	Color Options	Utility Label/Receptacle	Option
RUL	HT Horizontal Tenon	2ME Type II Medium  5ME Type V Medium	C 50W	30K 3000K 40K 4000K	12 120V	UF Grey Unfinished	N Utility Label and NEMA® 3-Pin Photocell Receptacle - Label per ANSI C136.15 - 3-pin receptacle per ANSI C136.10 - Requires photocell or shorting cap by others	ES 10kV Surge Suppression Protection CORD 7' Cord (Pre-Installed) ES-K1 Utility Kit - Includes: 10kV surge suppression protection, long-life photocell, 24" arm mount and 7' cord [pre-installed] ES-K2 Utility Kit - Includes: 10kV surge suppression protection, long-life photocell, 24" arm mount, NEMA® style reflector/refractor and 7' cord [pre-installed]



US: [creelighting.com](http://creelighting.com) (800) 236-6800

Canada: [creelighting-canada.com](http://creelighting-canada.com) (800) 473-1234

# RUL™ LED Rural Utility Luminaire

## Product Specifications

### CONSTRUCTION & MATERIALS

- Die cast aluminum housing w/UV stabilized polymeric door
- Clear borosilicate glass refractor
- Compatible with ANSI C136.6 reflectors/refractors
- Tool-less entry
- Mounts on 1.25" IP, 1.66" (42mm) O.D. or 2" IP, 2.375" (60mm) O.D. horizontal tenon (minimum 3" [76mm] in length) and is adjustable +/- 5° in 2.5° increments to allow for fixture leveling
- Luminaire secured with two 3/8-16 x 2.0" mounting bolts
- Comes standard with Utility Label per ANSI C136.15 and 3-pin NEMA® Photocell Receptacle per ANSI C136.10
- ES-K1 packages the following items in a single box for convenience:
  - RUL™ utility luminaire w/10kV surge suppression protection
  - Long-life photocell
  - 7' (2.1m) 14/3 SEOW cord (pre-installed)
  - 24.0" (610mm) curved raw aluminum arm mount w/zinc-plated steel hardware for mounting to wood poles
- ES-K2 packages the following items in a single box for convenience:
  - RUL™ utility luminaire w/10kV surge suppression protection
  - Long-life photocell
  - 7' (2.1m) 14/3 SEOW cord (pre-installed)
  - 24.0" (610mm) curved raw aluminum arm mount w/zinc-plated steel hardware for mounting to wood poles
  - NEMA® style reflector/refractor
- **Weight:** See Weight chart on pages 1 and 4

### ELECTRICAL SYSTEM

- **Input Voltage:** 120V, 60Hz
- **Power Factor:** > 0.9
- **Total Harmonic Distortion:** < 20%
- Integral 6kV surge suppression protection standard; 10kV optional w/ES, ES-K1 and ES-K2 options
- When code dictates fusing, a slow blow fuse or type C/D breaker should be used to address inrush current
- Electrolytic capacitor-free design provides high reliability
- **Operating Temperature Range:** -40°C - + 25°C (-40°F - + 77°F)

### REGULATORY & VOLUNTARY QUALIFICATIONS

- cULus Listed
- Suitable for wet locations
- Luminaire only certified to ANSI C136.31-2001, 3G bridge and overpass vibration standards
- ANSI C136.2 6kV surge suppression protection tested in accordance with IEEE/ANSI C62.41.2 on standard luminaires
- ANSI C136.2 10kV surge suppression protection tested in accordance with IEEE/ANSI C62.41.2 on luminaires w/ES, ES-K1 and ES-K2 options
- Meets FCC Part 15, Subpart B, Class A limits for conducted and radiated emissions
- DLC qualified. Please refer to [www.designlights.org/QPL](http://www.designlights.org/QPL) for most current information
- RoHS compliant. Consult factory for additional details
- **CA RESIDENTS WARNING:** Cancer and Reproductive Harm – [www.p65warnings.ca.gov](http://www.p65warnings.ca.gov)

Electrical Data*		
Input Power Designator	System Watts 120V	Total Current (A)
		120V
C	50	0.42

\* Electrical data at 25°C (77°F). Actual wattage may differ by +/- 10% when operating at 120V +/- 10%

RUL Series Ambient Adjusted Lumen Maintenance <sup>1</sup>						
Ambient	Input Power Designator	Initial LMF	25K hr Reported <sup>2</sup> LMF	50K hr Estimated <sup>3</sup> LMF	75K hr Estimated <sup>3</sup> LMF	100K hr Estimated <sup>3</sup> LMF
5°C (41°F)	C	1.04	0.97	0.92	0.87	0.83
10°C (50°F)	C	1.03	0.96	0.91	0.86	0.82
15°C (59°F)	C	1.02	0.95	0.90	0.85	0.81
20°C (68°F)	C	1.01	0.94	0.89	0.84	0.80
25°C (77°F)	C	1.00	0.93	0.88	0.84	0.79

<sup>1</sup> Lumen maintenance values at 25°C (77°F) are calculated per IES TM-21 based on IES LM-80 report data for the LED package and in-situ luminaire testing. Luminaire ambient temperature factors (LATF) have been applied to all lumen maintenance factors. Please refer to the [Temperature Zone Reference Document](#) for outdoor average nighttime ambient conditions.

<sup>2</sup> In accordance with IES TM-21, Reported values represent interpolated values based on time durations that are up to 6x the tested duration in the IES LM-80 report for the LED.

<sup>3</sup> Estimated values are calculated and represent time durations that exceed the 6x test duration of the LED.

**Photometry**

All published luminaire photometric testing performed to IES LM-79-08 standards. To obtain an IES file specific to your project consult: <http://creelighting.com/products/outdoor/street-and-roadway/rul-series>

**2ME**

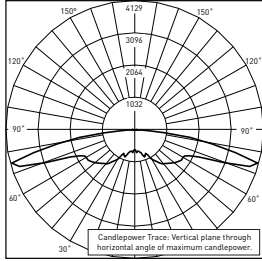

**RESTL Test Report #:** PL05401-001  
**RUL\*\*2MEC40K-12UFN**  
**Initial Delivered Lumens:** 5,454

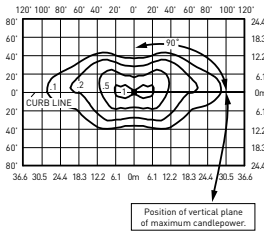

**RUL\*\*2MEC40K-12UFN**  
**Mounting Height:** 25' (7.6m) A.F.G.  
**Initial Delivered Lumens:** 5,560  
 Initial FC at grade

Type II Medium Distribution (also applies w/ES-K1 Option)				
Input Power Designator	3000K		4000K	
	Initial Delivered Lumens*	BUG Ratings** Per TM-15-11	Initial Delivered Lumens*	BUG Ratings** Per TM-15-11
C	5,215	B2 U2 G2	5,560	B2 U2 G2

\* Initial delivered lumens at 25°C (77°F). Actual production yield may vary between -10 and +10% of initial delivered lumens  
 \*\* For more information on the IES BUG (Backlight-Uplight-Glare) Rating visit: <https://www.ies.org/wp-content/uploads/2017/03/TM-15-11BUGRatingsAddendum.pdf>. Valid with no tilt

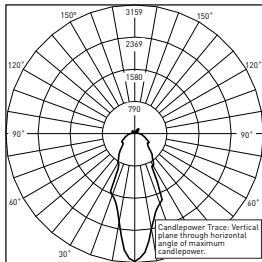

**RESTL Test Report #:** PL07270-001  
**RUL\*\*2MEC40K-12UFNES-K2**  
**Initial Delivered Lumens:** 4,659

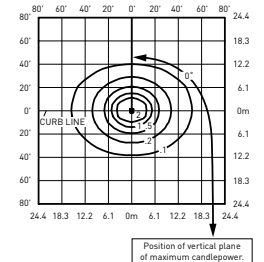

**RUL\*\*2MEC40K-12UFNES-K2**  
**Mounting Height:** 25' (7.6m) A.F.G.  
**Initial Delivered Lumens:** 4,659  
 Initial FC at grade

Type II Medium Distribution w/ES-K2 Option				
Input Power Designator	3000K		4000K	
	Initial Delivered Lumens*	BUG Ratings** Per TM-15-11	Initial Delivered Lumens*	BUG Ratings** Per TM-15-11
C	4,370	B2 U3 G1	4,659	B2 U4 G2

\* Initial delivered lumens at 25°C (77°F). Actual production yield may vary between -10 and +10% of initial delivered lumens  
 \*\* For more information on the IES BUG (Backlight-Uplight-Glare) Rating visit: <https://www.ies.org/wp-content/uploads/2017/03/TM-15-11BUGRatingsAddendum.pdf>. Valid with no tilt

**5ME**

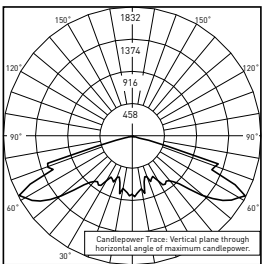

**RESTL Test Report #:** PL05399-001  
**RUL\*\*5MEC40K-12UFN**  
**Initial Delivered Lumens:** 5,645

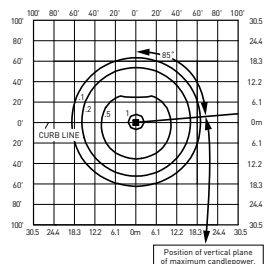

**RUL\*\*5MEC40K-12UFN**  
**Mounting Height:** 25' (7.6m) A.F.G.  
**Initial Delivered Lumens:** 5,682  
 Initial FC at grade

Type V Medium Distribution (also applies w/ES-K1 Option)				
Input Power Designator	3000K		4000K	
	Initial Delivered Lumens*	BUG Ratings** Per TM-15-11	Initial Delivered Lumens*	BUG Ratings** Per TM-15-11
C	5,365	B3 U2 G1	5,682	B3 U2 G1

\* Initial delivered lumens at 25°C (77°F). Actual production yield may vary between -10 and +10% of initial delivered lumens  
 \*\* For more information on the IES BUG (Backlight-Uplight-Glare) Rating visit: <https://www.ies.org/wp-content/uploads/2017/03/TM-15-11BUGRatingsAddendum.pdf>. Valid with no tilt

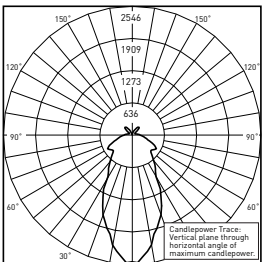

**RESTL Test Report #:**  
**RUL\*\*5MEC40K-12UFNES-K2**  
**Initial Delivered Lumens:** 4,515

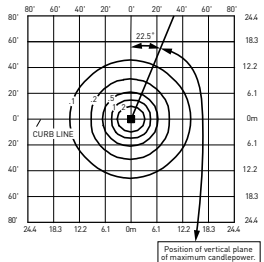





**RUL\*\*5MEC40K-12UFNES-K2**  
**Mounting Height:** 25' (7.6m) A.F.G.  
**Initial Delivered Lumens:** 4,515  
 Initial FC at grade

Type V Medium Distribution w/ES-K2 Option				
Input Power Designator	3000K		4000K	
	Initial Delivered Lumens*	BUG Ratings** Per TM-15-11	Initial Delivered Lumens*	BUG Ratings** Per TM-15-11
C	4,263	B2 U3 G2	4,515	B2 U4 G2

\* Initial delivered lumens at 25°C (77°F). Actual production yield may vary between -10 and +10% of initial delivered lumens  
 \*\* For more information on the IES BUG (Backlight-Uplight-Glare) Rating visit: <https://www.ies.org/wp-content/uploads/2017/03/TM-15-11BUGRatingsAddendum.pdf>. Valid with no tilt

**Luminaire EPA**

<b>Horizontal Tenon Mount</b> – Weight: 3.75 lbs. (1.7kg); RUL-ARM24/ES-K1 Option: add 1.82 lbs. (0.8kg); ES-K2 Option: add 3.07 lbs. (1.4kg); RUL-PEC; add 0.28 lbs. (0.1kg); RUL-REF; add 2.20 lbs. (1.0kg)					
Luminaire	Single	2 @ 90°	2 @ 180°	3 @ 90°	4 @ 90°
<b>Tenon Configuration</b> If used with Cree tenons, please add tenon EPA with luminaire EPA					
					
Standard Luminaire	0.28	0.46	0.56	0.74	0.92
Luminaire w/ES-K1 Option or RUL-PEC	0.70	1.76	1.40	2.46	3.52
Luminaire w/ES-K2 Option or RUL-PEC & RUL-REF	1.54	3.45	3.09	4.99	6.89
Luminaire w/RUL-REF	1.12	2.14	2.24	3.26	4.28

**Tenon EPA**

Part Number	EPA
RUL-ARM24	0.42

Tenons and Brackets*
<b>Arm Mount</b> RUL-ARM24 - 24.0" (610mm) curved raw aluminum arm mount - Includes zinc-plated steel hardware - Mounts to wood poles

\* Refer to the [Bracket and Tenons spec sheet](#) for more details



RUL Luminaire shown with photocell and reflector/refractor; ES-K2 Option also includes 10kV surge suppression protection, 7' cord, and arm (not shown)

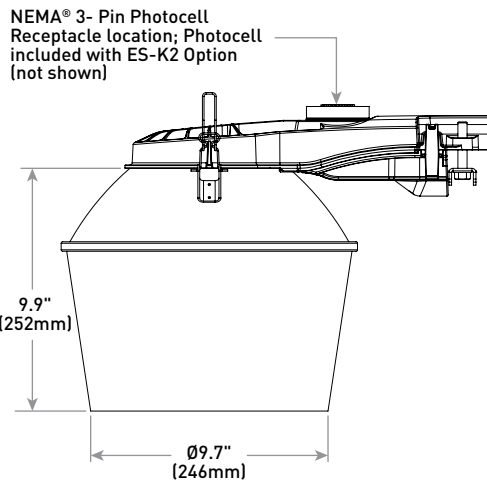

Luminaire w/ES-K2 Weight
6.82 lbs. (3.1kg)